

Project Number:	DE 3006
Project Title:	MORE - MOBILE RESCUE phone
Deliverable Type :	PD

Deliverable :	D11
Contractual Date of Deliverable	31 03 2000
Date of Delivery :	24 03 2000
Title of Deliverable :	Reports and Demonstration to other interested groups
Work-Package	WP7
Nature of the Deliverable :	RE
Dissemination level:	PU
Authors:	fortec, BENEFON, IfADo, IMS, Stakes

Abstract:
This deliverable D11 describes the reports and demonstration given to interested groups about the background and results of the MORE project.
The EU project MORE aimed at developing the prototype of a new GSM mobile phone integrating both mobile telephony and alarm functions into one easy to use device for the disabled and older people – the MORE phone. Supplementing this device an alarm and service centre model has been developed which allows, despite acting as a centre for emergency calls, to provide additional services to the MORE users.
The reports to interested groups (public report D7-2 and D7-3), included in this deliverable, want to provide an overview on the achieved results with the prototypes built, the knowledge gathered during the project and demonstrate the possibilities that arise from this new technology by describing specific usage scenarios.
The public report is distributed to interested groups, industry and service providers and is also available via Internet for download at
“http://www.fortec.tuwien.ac.at/morepub_report.html”.

***Type: PU-public, LI-limited, RP-restricted**
****Nature: PR-Prototype, RE-Report, SP-Specification, TO-Tool, OT-Other**

MORE Deliverable Numbering D11/PD/PU/fortec/F/17-03-2000

<i>ID</i>	<i>Official Deliverable ID (D??)</i>
<i>TYPE</i>	<i>PD project deliverable (goes to the Commission)</i> <i>X internal to project, available on demand to the CEC</i>
<i>DLEVEL</i>	<i>Dissemination Level:</i> <i>PU public deliverable</i> <i>LI limited to other projects in the Telematics programme</i> <i>RP restricted to the Consortium members</i>
<i>RESPID</i>	<i>Responsible Partner ID</i>
<i>STATUS</i>	<i>W-n Working document, version n</i> <i>P-n PRELIMINARY complete version for discussion, version n</i> <i>D DRAFT, before peer review</i> <i>F FINAL VERSION, after peer review</i>

LIST OF AUTHORS**Fortec**

Favoritenstraße 11/366-1B
A-1040 Wien
AUSTRIA
Tel: +43 1 58801 76611
Fax: +43 1 58801 36697

STAKES

Siltasaarenkatu 18, 3. Krs, ITSE-yksikkö
00531 Helsinki
FINLAND
Tel: +358 9 3967 2056 or +358 9 3967 2480
Fax: +358 9 39672054

BENEFON OYJ

Meriniitynkatu 11
24101 Salo
FINLAND
Tel: +358 2 77400
Fax: +358 2 77 40 333

IMS

Allmandring 30a
70569 Stuttgart
GERMANY
Tel: +49 711 685 5939
Fax: +49 711 685 5930

IfADo

Ardeystrasse 67
4139 Dortmund
GERMANY
Tel: +49 231 1084 265
Fax: +49 231 1084 308

CONTENTS

1	INTRODUCTION	7
1.1	Public Presentations and Speeches	7
1.2	Demonstration Schedule	8
1.3	Summary of Demonstration Events	9
1.3.1	DAV tests with users	9
1.3.2	KLS demonstration to users	12
1.3.3	JUH demonstration to users	13
1.3.4	RFVG demonstration to users	15
1.3.5	RFVG demonstration to experts/service providers	16
1.3.6	OBH demonstration to users	17
1.4	Service Conference at KOT	20
1.5	Feedback from SAFE21 project	20
1.6	Conclusions	20
2	THE MORE PROJECT – AN OVERVIEW	22
2.1	Project Summary	22
2.2	Project Workplan 1997 – 2000	23
2.3	Project Partners	23
2.4	The Product and Service and its Application	24
2.5	Work Within the Project	25
3	THE MORE CONCEPT	26
3.1	User Background – Europe and Test Sites	29
3.2	User Needs	29
3.3	Transfer of user needs to design	30
3.4	Implementation of Objectives	33
3.4.1	MORE MMI from User’s View / Access to Mobile Communication	33
3.4.2	MORE SOS Call from User’s View / Access to Emergency Call	34
3.4.3	MORE Tracking from User’s View / Access to Localisation	34
3.4.4	MORE from MSC User View / Service Centre Implementation	34
4	ADVANTAGES FOR D&E MPH USERS	36
4.1	Hearing impaired	36
4.2	Visually impaired	37

4.3	Mobility of upper extremities, dexterity impaired	38
4.4	Mobility of lower extremities, mobility impaired	38
4.5	Speech impairment	38
4.6	Cognitive impairment, language impairment and dyslexia	38
4.7	Problems with consciousness, safety or increased risk	39
4.8	Usage Scenarios	39
5	FIELDS OF MORE APPLICATION	43
5.1	Provision of services	43
5.1.1	Support by MSC:	43
5.1.2	Telecom providers	43
5.1.3	Alarm call providers	43
5.1.4	Homes for the D&E	43
5.1.5	Visit and home care service providers	43
5.1.6	Cost Reduction for Municipalities and Governments	44
5.1.7	Relatives	44
5.2	Application for Equalisation of Opportunities	44
5.2.1	Application for social communication	44
5.2.2	Application for learning and work	44
5.3	Application for safety and security	45
5.3.1	Increasing accessibility of alarm and emergency services	47
5.3.2	Reducing Fear of Illness	47
5.3.3	Reducing Fear of Accidents	47
5.3.4	Reducing Fear of Violence	48
5.3.5	Reducing Fear of Loneliness	48
5.3.6	Increasing Awareness of Warning Signals	48
5.4	Application in social system	48
5.4.1	Savings due to early care	48
5.4.2	Reduced need for home care	49
5.4.3	Reduced institutionalisation	49
6	DESIGN CONSIDERATIONS IN MORE	50
6.1	Design considerations for the MPH function blocks	50
6.1.1	Body	50
6.1.2	Keys	50
6.1.3	Display	51
6.1.4	Audio	52
6.1.5	Power supply	52
6.1.6	SOS call	53
6.1.7	GPS	53
6.1.8	Antenna	53
6.1.9	Functions	53
6.1.10	MORE Hook-On (TECOK)	54
6.1.11	Interfaces	54

6.2	MSC overview	55
6.2.1	MGW	55
6.2.2	Front End	55
6.3	Design considerations for the MSC function blocks	57
6.3.1	MSC GUI	57
6.3.2	PSTN lines	57
6.3.3	GSM-SMS interface	58
6.3.4	Electronic Map	58
6.3.5	Database	58
6.3.6	MRS	58
6.3.7	MSC functions	59
7	OVERVIEW ON MORE FEATURES	60
7.1	Vision Related Features	61
7.2	Emergency/SOS Related Features	62
7.3	Easy MMI Related Features	63
7.4	Motion Related Features	64
7.5	Hearing Related Features	65
7.6	Safety Related Features	66
7.7	MSC Related Features	67
8	ACCESSORIES TO MPH FOR SPECIAL USER GROUPS	68
9	CONCLUSIONS	70

GLOSSARY OF TERMS AND ACRONYMS

ASIC	Application Specific Integrated Circuit
BB-PCB	BaseBand-Printed Circuit Board
C/A Code	The Coarse/Acquisition code
CEPT	Conférence Européenne des administrations des Postes et Télécommunications
DGPS	Differential Global Positioning System
DTMF	Dual Tone Multi Frequencies
EEPROM	Electrically Erasable Programmable Read Only Memory
EMI	Electromagnetic Interference
ESD	Electrostatic Discharge
ETSI	European Telecommunications Standards Institute
GPS	Global Positioning System
GSM	Global System for Mobile Communications
GSM MOU	GSM Memorandum Of Understanding
GSM PLMN	GSM Public Land Mobile Network
HF	Hands Free
IfADo	Institut für Arbeitsphysiologie
IMEI	International Mobile Equipment Identity
IMSI	International Mobile Subscriber Identity
ISDN	Integrated Services Digital Network
MRS, MGRS	MORE GPS Reference Station
MPH	MORE Phone,
MSY	MORE System, all equipment: MPH, MSC, TECOK, MRS plus services
MUC	MORE User Club
MMI	Man Machine Interface
MPCS	MORE Phone Chip Set
MPH	MORE Phone
MS	Mobile Station
MSC	either 1) Mobile-services Switching Centre or 2) MORE Service Centre
NiMH	Nickel Metal Hydrid
NMEA	National Marine Electronics Association
NMT	Nordic Mobile Telephone
Rx	Receiver
SIEM	Speech Intelligibility Enhancement Module
SIM	Subscriber Identity Module
SMS	Short Message Service
SNR	Signal to Noise Ratio
TECOK	TeleCOnnector Kit for Hearing Aids and Mobile Phones
Tx	Transmitter
	Universal Time Coordinated

1 Introduction

The EU project MORE aimed at developing the prototype of a new GSM mobile phone integrating both mobile telephony and alarm functions into one easy to use device for disabled and older people – the MORE phone. Supplementing this device an alarm and service centre model has been developed and tested which allows, despite acting as a centre for emergency calls, to provide additional services to the MORE phone users.

This deliverable D11 describes the reports and demonstration given to interested groups about the background and results of the MORE project.

During the project MORE was presented at several conferences and fairs with the developed prototypes but also in form of videos and speeches. Within the last months of the project demonstration activities like conferences, public demonstrations and publications introduced the MORE concept to the public and interested groups.

The reports to interested groups (WP7 D7-2 and D7-3), included in this deliverable (starting with chapter 2), want to provide an overview on the results achieved with the prototypes built, the knowledge gathered during the project and demonstrate the possibilities that arise from this new technology by describing specific usage scenarios. The public report is distributed to interested groups, industry and service providers and is also available via Internet for download at "http://www.fortec.tuwien.ac.at/morepub_report.doc".

1.1 Public Presentations and Speeches

During the whole project the partners undertook activities to go public with the MORE idea. Following a list of those activities:

- Brochure (IMS)
- Website (fortec)
- Promotion video clip (IMS)
- Public presentation of the project "Information Day – University of Stuttgart" (IMS)
- TIDE Congress, Helsinki (J. Sandhu), (Benefon, IMS, fortect)
- Focus Group of D&E Organisations (STAKES)
- Smart Homes & Telematics Conference (IMS)
- MORE Brochure and MORE Website (Benefon)
- IST 98 conference (fortec, Benefon, IMS)
- CeBIT Exhibition (Benefon)
- Hannover Messe, Industry Exhibition (IMS & Landesgewerbeamt Ba-Wü)
- Headline in COST219bis Newsletter 3/99 (RNIB)
- MORE Video (STAKES)
- TELECOM Exhibition, Geneva (Benefon, EC/IMS)
- 2nd IADS Meeting Brussels (IMS)
- Europa Fachtagung der Berufsbildungswerke - Conference, Potsdam (OBH, IMS)
- EMBEC 99 conference, (fortec)
- HCI International, Munich (J. Sandhu)
- 4th Global Conference of the Int. Federation on Ageing, Montreal (J. Sandhu)
- Robens Institute on Health, University of Surrey, Disability Seminar (J. Sandhu)
- Malta Commission on Disability "Developments in Europe", Vileta (J. Sandhu)
- 5th European Conference for the Advancement of Assistive Technology (IfADo)
- ICCHP 2000, Karlsruhe (fortec)

1.2 Demonstration Schedule

For the demonstration the same equipment as for the final verification was used. Only minor updates of the MPH SW changing the factory settings were made before the demonstration tests (details are described in WP6 deliverable D6-5 and WP7 deliverable D7-1).

Status of MSC:

For the MSC in the beginning of the project a PC platform was chosen that gave enough freedom for implementing all functions. A HW abstraction layer was implemented in SW that allowed to access the HW from a GUI SW in a very easy way.

For the GUI SW first a sketch was developed which, at the implementation level, could not be successfully completed with the chosen development tools. Therefore in a consortium meeting in Gerlingen in March 1999 it was decided to redo the GUI development from scratch. Finally a basic GUI that supports all functions for testing could be achieved.

For the final production GUI better user support and more user friendliness is recognised to be needed.

The GPS reference station (MRS) connected to the MSC via a serial link was implemented as a separate PC based device. SW updates fixed some detected minor bugs.

Status of MPH:

During the project the development path for the MPH, that is the front end visible to the D&E users, led from paper mock-ups via a wooden model to a modified series device and to the first laboratory prototypes delivered within WP5. The verification prototypes were continuously improved during WP6 and, despite the too big size and too high weight, have reached the goal regarding the mechanical and visual properties (except display light contrast). The final prototype was equipped with all the functionality but still suffered from unsolved stability problems and, because of this, in parts incomplete MMI. The MPH was produced in two different versions with either complete numeric keyboard or only 4 pre-programmed dial buttons.

The MMI concept was not completely implemented for all states, so several display texts still weren't available in big font or with the standardised layout.

The full integration of display information with sounds and speech output was not available, only single events had associated sound or speech messages (in few prototypes).

Voice quality during calls was rather poor and hands-free was not usable because of an internal feed-back loop.

Speech output of the MPH was tested only with expert users since the implementation problems would have too much reduced the extent and quality of end user testability. Results from experts and representatives of disability organisation testing provided useful feedback, showing how the speech feedback concept should be developed for special user groups and verifying the demand to include it in the production-ready device.

Configurable speech messages for SOS were also not available in the prototypes.

Even though the text telephony was not supported from the beginning Benefon has contacted various national organisations and international manufacturers of text telephones. Although the standardisation exists, manufacturers have not yet adopted the newest standards and thus the range of supported standards varies greatly in Europe. This causes difficulties to design accessories that would work with all equipment. As a provisional solution text communication over SMS can be used. Despite this, a prototype for text communication via special audio tones was developed and tested, and a method for text communication via DTMF according to the Danish text telephone standard was investigated.

Status of Accessories and TECOK:

The TECOK for hearing aid users of the MPH was implemented for testing in a neck-worn prototype with 4 pre-programmed settings for

- no (neutral position),
- minor,

- moderate
- and severe

hearing impairment. After some iterations in fitting the TECOK to the MPH signals a full functioning prototype was ready for verification and demonstration tests with users. A special software running on a PC could additionally be used to input pre-recorded sound samples into the TECOK and to control the parameters from PC.

A set of general accessories for charging, carrying and mounting of the MPH prototype was available which were considered good usable during the user tests. From the tests it was found that more specialised carrying and mounting aids need to be provided for the commercial product.

None of the specified more specialised in- or output accessories to the MPH were available with the prototype because of the incomplete MPH interface.

1.3 Summary of Demonstration Events

Because of the status of the MORE prototypes it was decided to follow the principle to only focus on certain scenarios also for the demonstration. This scenarios included powering on/off the MPH, making and receiving of calls and the SOS call function.

The layout of the demonstration tests was made such that the test sites could demonstrate the MORE system to many persons in a short time to gather as many feedback as possible. The single demonstrations events were typically arranged as follows:

- An introduction phase of not more than ½ hour. This should give enough background information on the MORE project and MPH for the user. A video (from STAKES or IMS) or slides, if applicable, was used and the general instruction sheets from the verification tests provided a basis for the introduction on MORE functions.
- A demonstration phase of not more than ½ hour demonstrating the most important functions: Power ON/OFF, SOS with localisation, making a call, receiving a call.
- A variable hands-on period with support from staff to try the basic functions and answer individual questions
- A recording of statements on utility and usability “at the first glance” with user background: sex, age, impairment or field of expertise, comments/problems

All 6 MORE test sites participated in the demonstration of the MORE results to interested end users and organisations. Every site organised demonstrations for their national environment with reports about the project, explanations of the function of the MSY and hands-on experience for the participants. From the feedback important additional conclusions for the redesign specification could be drawn. A total of about 200 potential users of the MSY participated during the demonstration events.

The test sites additionally or within the demonstration to users established contacts to local service providers who were considered to be potential MORE service providers. Many of the test sites would also themselves be interested in running MORE services.

1.3.1 DAV tests with users

The DAV, because of its special clients (hikers, mountaineers, skiers), has made combined verification and demonstration tests with users in the mountain area of the German alps. 8 expert users where given a MPH for at least 2 (max. 5) days for free trials. 2 persons were equipped with a MPH and an external GPS antenna and tracked during their ski tours. The results regarding tracking performance and accuracy are documented in D7-1.

Prior to the test phase the MORE system was explained in detailed to every user, especially the use of the MPH (because no German manual was available, although the English manual was understood). The basic functions where shown and sample position request were made to explain the procedure.

Most of the test time the MSC operator was reachable via phone for the absolutely necessary technical support.

The participating users represent a sample typical for the DAV clients. The average age of the test persons is 42, the youngest was 25 years, the oldest 56 years. The experience with GSM and GPS technology is shown in Table 1).

	User1	User2	User3	User4	User5	User6	User7	User8
Experience with GSM	1	2	1	1	2	2	0	1
Experience with GPS	1	2	1	1	1	2	0	1

Table 1) Experience in GSM/GPS technology
 Rating: 0=no experience, 1= some experience, 2= much experience

Except user 5 all had at least some experience in usual GSM and GPS technology.

Following some more detailed descriptions about the persons' usual environment when using GSM/GPS and experiences made with the MSY during their test time.

User1):

The test person often goes hiking, skiing or rock climbing also in foreign countries, e.g. Nepal, Russia. Some years ago she made a sailing boat trip where she could make good experiences with a satellite phone.

Experiences with the MPH:

Her first impression of the MPH is, that the device is too heavy and too big.

After using the Phone for 3 days, she said that the MPH is really good to use. So she had no problem while performing several tasks like: send/receive a SMS, make an alarm call, go through the menu, change settings and so on. She only had problems with the instable software and some unclear display messages (related to GPS).

The test person pointed out, that the MPH is quite easy to use when you have some experiences with mobile phones. This statement differs very from the opinion of other expert user, but we should keep in mind, that the main target group are the disabled and elderly.

User2)

The user is a member of the mountain rescue service. He is experienced in using mobile phones, radio devices and GPS.

Experiences with the MPH:

The user tested the mph for 5 days. He performed several tasks (all functions which are also present in a normal mobile phone) without any bigger problems. But he stated that there must be a lot of improvements before the MPH can be given to the public; e.g. the MPH must be more easily surveyed, more handy, completely stabile and lighter. This user also participated in the GPS function tests (mainly tracking).

User3)

Experiences with the MPH:

The user was often not able to handle the situations caused by the instability of the MPH. He also he had some difficulties with the normal functions of the MPH (scrolling through the menu, edit names...). But he pointed out that he had the same problems when he tried the same tasks with a Nokia mobile phone. A positive thing for him was the size of the keys and the big display. The weight and the thickness of the MPH was not acceptable for him.

User4)

He often goes hiking, skiing and mountain biking.

Experiences with the MPH:

In general the user was satisfied with the MPH. After explaining and demonstrating some tasks (send SMS, edit names, store numbers in the phone book, change the MORE settings and the general settings) he immediately was able to do these task almost independently. He criticised the weight of the MPH and the instability of the software, but he also pointed out that it is very easy to make an alarm call and emphasized the importance of this function.

User5)

The user practises outdoor activities like hiking, mountain climbing and biking.

Experiences with the MPH:

The user was not so thrilled by the MPH, because she compared it automatically with her own mobile phone. So she criticised the instability of the system, the unclear messages (GPS messages) , the weight and size, the bad speech quality and the GSM functionality as such. She wants to have the possibility to show her position on the MPH (on a map). With he standard functions of the MPH she had no problems, because she is used to them.

User 6)

As outdoor activities he goes hiking, skiing and mountain biking. Especially for his mountain bike tours he would use such a device like the more system.

Experiences with the MPH:

Because of his experiences the user has no problems to handle the normal functions of the MPH, only the unclear messages concerning the GPS functions caused some problems. He stated that the size of the housing and the keys are pretty good, also the easy way to make an alarm call. But also he criticised the weight and the general instability and reliability of the MPH (He had several crashes after using the GPS).

He would find it very useful to have the possibility to show the positions on a map direct on the MPH.

User7)

She had some experiences with a home care service, because one of her relatives uses such a service. In her holidays she often goes hiking in Norway and Sweden.

Experiences with the MPH:

The user had no problems with the basic functions of the MPH like make or receive a call or make a SOS call. But with the other functions of the phone she had several problems, because she never used it before. At the end of the test she stated, that she only would use the basic functions of the MPH and, of course, the SOS function.

User8)

As outdoor activities he goes hiking, climbing and paragliding.

Experiences with the MPH:

Except with the 'MORE' menu point the user had no bigger problems with the menu structure. He criticised the instability of the system and the weight of the MPH.

Rating on satisfaction with the phone and the system can be seen in Table 2)

	User 1	User2	User3	User4	User5	User6	User7	User8
The MPH has been pleasant to use	7	2	3	4	5	2	5	6
The MPH is good looking to use	6	2	5	6	3	4	5	3
The phone was efficient to use	7	2	2	2	3	2	4	2
The MPH offered good support in the tasks the user	7	1	6	2	4	6	2	3

wanted to do								
User felt in control of the MPH all the time	6	3	6	6	6	5	3	4
It was easy to learn to use the MPH	6	3	2	6	6	5	5	5

Table 2) Satisfaction with the MPH and MSY
 Rating: 0= completely disagree to 7 = completely agree

Summary:

All the users were in principle interested in such a system like the MORE system once it is stable. If they would buy it or not depends mostly on the price of the device.

Service provider contacts:

In the area around Munich 4 potential service providers who currently run alarm services were contacted:

- Malteser-Hilfsdienst e.V. (Malteser)
- BRK (Bavarian Red Cross)
- JUH e.V. (Johanniter)
- ASB Landesverband Bayern e.V. (Samariter)

Their alarm call services are provided at fees between 25-30 € per month. A well functioning mobile alarm call system, once available, would be interesting for them and a precondition for tests.

1.3.2 KLS demonstration to users

Because the potential users of the MORE system in KLS have very different disabilities like aphasia, pareses, light forms of amnesia etc., it was difficult to demonstrate the system to groups of users. Therefore it was demonstrated to 20 single patients by three interviewers (therapists of the respective patient). From their experiences in therapy they selected those patients for which the MORE system probably could be useful.

The MPH and the MSY was introduced and explained in short to the single patient. Because the video of Stakes seemed to be too confusing to the patients because of simultaneous translation and explanation, the MSY was only verbally explained by the interviewer.

For most of the patients only basic functions of the phone were demonstrated: Power on/off, making and receiving a call, and the SOS call.

In a hands-on period of variable time between half an hour and some hours at different days the user could try to use the phone him/herself, always under supervision of and with support by the interviewer. Most of the patients only tried simple functions like making standard calls or SOS calls. Unfortunately almost never a communication between MPH user and the MSC was possible because in most cases the phone broke down while the SOS procedure was running. It was also not possible to give the phone to the users for some time without supervision because of the various technical deficits, e.g. frequent total breakdowns with the need to reset the device.

At the end of the demonstration the users basic data as well as his comments about utility and usability were recorded. The patients were first asked whether such a system could be of use for them if all functions would be working and all errors had been removed. Then they were asked whether the phone as it is can be used for this purpose.

The average age of the participating users was 50 years, the oldest was 74 years, the youngest was 28years.

The distribution of disabilities of the users can be seen in Table 3).

Disability	Nr. of persons
Hearing problems	5
Problems with voice/speech	11
Visual problems	3
Problems in using upper extremities	5
Problems in locomotion	4
Difficulty in reading and writing	10
Psycho-cognitive problems	12
Lack of willingness to use technology	7

Table 3) Disability of demonstration participants from KLS.

Most of the users with difficulty in reading/ writing and with psycho-cognitive problems suffer from aphasia (mild to severe)

Usability/Utility	Yes	Maybe/ somewhat	No
Is the phone of use	9	6	5
Can the phone be used	4	4	12

Table 4) Usability and utility rated by the KLS –demonstration participants

As can be seen from Table 4) only 5 (i.e. a quarter of the sample) rated the phone not being of use for them. In comparison to that more than half of the participants rated the phone as not usable by them.

Reasons for being not usable where the phone being too heavy (3 persons) missing speech output especially during the SOS call (1 person) the poor speech quality (1 person) and the permanent breakdowns of the phone and it's instability (7 persons).

Not being of use was stated by those persons with too much memory problems or with too great aversion to the technology.

The instability of the phone was the main reason why most of the users would see the MSY as possibly useful but as completely unusable in the present state. Other problems are the weight of the phone, its complexity, lacking equipment to carry it, and the potential costs of the system.

Service provider contacts:

The most reasonable provider for a MSY in the KLS region is the local rescue service centre, which is reached when calling 112. This centre is run by the German Red Cross.

The people there were informed about the MORE project and asked whether they would be interested in installing such a system in their centre. The answer was “yes” under the precondition that the system would be working good enough for their purposes.

1.3.3 JUH demonstration to users

JUH organised 4 events where the MORE System and project were demonstrated to a pool of about 100 elderly technophobe and disabled people.

The locations and numbers of participants are as follows:

- 14 people where visited in their own apartments/flats
- 20 people joined a meeting in the JUH’s meeting-room
- 34 people in an old people’s house (run by the City of Vienna)
- 29 people in an old people’s house (run by Caritas Socialis)

This means a total of a total of 97 persons joined these events. This group represents a realistic cross-section of the clients of JUH’s alarm services in Vienna regarding both their state of health as well as in their age and their social position.

The system was first presented and explained in short to the attendants. Due to the relatively large number of attendants only basic response data was collected and time for hands-on test with the MPH was restricted to simple call tasks. Users basic data as well as utility and usability comments were reported.

The average age of the participants is 69 years, the youngest was 40 years, the oldest was 89 years. There have been 53 female and 44 male subjects.

Table 5) shows the distribution of disabilities amongst the participants:

Disability	Nr. of persons
Hearing problems	22
Problems with voice/speech	8
Visual problems	53
Problems in using upper extremities	18
Problems in locomotion	24
Difficulty in reading and writing	21
Psycho-cognitive problems	15
Lack of interest to use technology	28
Variations in level of consciousness	12

Table 5) Disabilities of the participants

- Of all the participants 72 persons (74%) rated the presented phone both useful and usable and gave no remarkable comments.
- Eight users stated that the MPH is useful in general, but not usable in it’s present state or not needed by the respective person.
Summarised comments of these persons: One person found the MPH too complex, one said that she had not enough money to buy it (but did not give a number related to costs), four persons found it too heavy and bulky to be used by them, one stated that there is no need to have it, and one said that GPS is dangerous (remark: the last statement was given by a person with psychological problems)
- 16 users (16%) rated the phone neither useful nor usable.
Reasons for this rating are summarised as follows (The number indicates the number of persons stating the respective fact).
 - 1: Person is not interested
 - 7: too complicated
 - 1: no comment
 - 2: present home care system is easier to handle
 - 3: too expensive
 - 1: no need to have it
 - 4: child/spouse lives with respective person and can help
 - 2: preferred to use own GSM phone
 - 1: and states that the MPH looks like 10 years old
 - 2: “no” without further comment
 - 1: GPS is not needed and phone is too big and heavy

Service provider contacts:

As the test site itself runs an emergency call centre for the city of Vienna and also a senior alarms system, JUH would be very interested in the application of the MSY. About 50% of the senior alarm clients already expressed their interest in a mobile system. Additional benefit is envisaged for the rescue service, once a well functioning system is available.

1.3.4 RFVG demonstration to users

Three meetings were arranged with potential MORE users. The MORE system was presented and an introduction on the usage of the phone was given. There was time reserved for the test persons to do some basic tasks and finally there was a questionnaire on basic questions filled out.

Usefulness of some MPH features and difficulty level of operation was rated. General comments were collected and a report about basic user data was produced.

An overall of 20 users were present at the meetings. Due to the fact that some of the users preferred to fill out the questionnaires together, a final number of 12 independent answers remained for evaluation. Nevertheless the opinion of the other 8 persons are also reflected in the comments.

The group was quite inhomogeneous as there were both lead users (elderly) and (younger) expert users

The distribution of disabilities amongst the test persons can be seen in Table 6)

Disability	Mild	Severe
Hearing problems	3	0
Visual problems	6	2
Problems in using upper extremities	4	0
Problems in locomotion	5	3
Difficulty in reading and writing	4	0
Problems in memorising	1	1
Cardiac problems	3	0
Asthmatic problems	1	0
Diabetics problems	0	1

Table 6) Disabilities of the participants

All of the test persons except one are used to handle push button telephones.

Five of them have a mobile phone, and ten of them have relatives who have a mobile phone.

Five of the them have problems or fear using new technology. Both the full and the four key version of the phone was used by all persons joining the events.

After the free trial phase the users were asked to rate questions about usability and utility of the phone and to give comments on the MSY.

Question asked	Answers (Numbers of test persons)		
Making a phone call (dialling area code and number and speaking to the person called) with the MPH is EASY	Yes (8)	Quite (2)	No (1)
Storing frequently used numbers (simply by pressing 1 key, ex. 1, 2 + OK to send the call) is USEFUL	Very (6)	Quite (6)	Of no use (0)
Receiving a phone call (and talking to the caller) is EASY	Yes (10)	Quite (2)	No (0)
Activating the SOS button, observing the call and waiting for MSC to answer is EASY	Yes (11)	Quite (1)	No (0)

Sending written messages (SMS) to the MSC and receiving them from the MSC is EASY:	Yes (3)	Quite (6)	No (3)
Sending written messages (SMS) to the MSC and receiving them from the MSC is USEFUL	Very (5)	Quite (4)	Of little use (3)
The MSC's possibility to localise at any time, any user outdoors via satellite, and tracing him/her on a digital map is USEFUL	Very (11)	Quite (1)	Of little use (0)
Putting the MPH under charge every night (or anytime the battery requires charging) is EASY	Yes (9)	Quite (3)	No (0)
Locking and unlocking the keys is EASY	Yes (5)	Quite (6)	No (1)
Setting automatic check calls from the MSC is USEFUL	Very (5)	Quite (5)	Of little use (2)

Table 7) Answers to questions asked at demonstration event at RFVG

1.3.5 RFVG demonstration to experts/service providers

A second event took place on one day where 12 experts from eight different institutions (5 Social Health Districts and 3 Municipalities) were present. Again the MORE system was presented and explained. Seven full key versions of the phone and two 4-key versions were used.

A free trial phase was followed by an evaluation questionnaire. Each test form was filled out by one institution, even if it was represented by more than one expert.

All the interviewed experts often (or at least sometimes) come in contact with elderly, physically disabled and persons with serious pathologies.

All of them have clients who use a push button telephone or additionally a cordless pushbutton telephone and one of them represent also clients with knowledge in GSM.

After the free trial the following rating to specific questions was given by the experts:

Question asked	Answers (Number of persons)		
Making a phone call (dialling area code and number and speaking to the person called) with the MPH is EASY	Yes (4)	Quite (4)	No (0)
Storing frequently used numbers (simply by pressing 1 key, ex. 1, 2 + OK to send the call) is USEFUL	Very (5)	Quite (3)	Not (0)
Receiving a phone call (and talking to the caller) is EASY	Yes (5)	Quite (3)	No (0)
Activating the SOS button, observing the call and waiting for MSC to answer is EASY	Yes (7)	Quite (1)	No (0)
Sending written messages (SMS) to the MSC and receiving them from the MSC is USEFUL	Very (1)	Quite (6)	Of little use (1)
The MSC's possibility to localise at any time, any user outdoors via satellite, and tracing him/her on a digital map is USEFUL	Very (6)	Quite (2)	Not (0)
Putting the MPH under charge every night (or	Yes (0)	Quite	No (0)

anytime the battery requires charging) is EASY		(8)	
Locking and unlocking the keys is EASY	Yes (0)	Quite (8)	No (0)
Setting automatic check calls from the MSC is USEFUL	Very (4)	Quite (2)	Of little use (2)

Table 8) Questions and ratings from the second demonstration event at RFVG

Impressions and comments were also collected after the free trial phase.

Who do you think the service should be mainly addressed to:	Elderly (2)	Physically disabled (8)	Others (2)
---	-------------	-------------------------	------------

The 'others' statement mean:

Persons with reasonable self-sufficiency and moderate disability

Any other group of persons with sanitary problems (pathologies)

Which areas do you think the service should be mainly addressed to?	Isolated mountain area (3)	Mountain areas in general (5)	Rural areas (4)
---	----------------------------	-------------------------------	-----------------

It was also stated, that any other area is also to address by the MSY by one person.

In your opinion how would the service be accepted by the user?	Quite easily accepted (0)	With some difficulty (7)	With great difficulty (1)
--	---------------------------	--------------------------	---------------------------

The rating for great difficulty was not further explained.

Do you think that the service could bring benefits in the long or mid term and if so which ones?	Security (7)	Independence (3)	Autonomy (3)
--	--------------	------------------	--------------

It can be seen, that the system and the provided functions are rated quite good, and that there is seen much benefit in the anticipated final product.

As final comment, the RFVG test site stated that a real interest was noted both from older people and experts with the constant request that the technical equipment (MPH and MSC) should be connected with a net of services similar to the one they know at the moment, that is the current telephone emergency service provided all over the regional territory.

1.3.6 OBH demonstration to users

42 disabled persons participated in the demonstrations.

As OBH is a school for vocational training of impaired children, the MSY was demonstrated to the clients in two ways.

7 group-meetings were held and several individual demonstrations/interviews were conducted. The meetings lasted ca. 2 hours and consisted of showing the MORE video, a short explanatory lecture, a hands-on phase, interviews, and a question&answer period. The MORE system was introduced in short and the usage of the phone was described. The test persons where allowed to do some basic tasks with the phone, usually calling, receiving calls, SOS but also SMS writing if wanted by the user and if time allowed. After the trials utility and usability of the phone was rated and comments collected.

The average age of the users is 27 years, the oldest was 77, the youngest was 17 years.

Disability	Nr. of persons
Hearing problems	3
Problems with voice/speech	9
Visual problems	2
Problems in using upper extremities	20
Problems in locomotion	33
Difficulty in reading and writing	5
Psycho-cognitive problems	5

Table 9) Disabilities of users

About half of the test-persons use a wheelchair. As can be seen from Table 9) half of them has problems in using arms or hands (spasticity, MS).

All of the test persons rated the phone and the system as such both useful and usable in it's anticipated final form but presently to be in a state not acceptable for permanent usage.

One main concern of nearly all the participants, which was not highlighted on the demonstration interview forms, was the financial aspect of purchasing a MPH and corresponding services. Several very specific questions were asked. For example, some feared having to pay a high fee for making an SOS which the rescue services might not classify as a true emergency. Epileptics, for example, could make an SOS call at the start of a seizure, but be in perfect condition 5 or 10 minutes later when the rescue services arrive.

Comments and ideas for improvement:

10: Too big and heavy (fellow trainees called the MPH a telephone-booth)

2: The Menu system too complicated. Users GSM-phone is much easier to use.

1: worried about the possibility for misuse by the wrong people (in reference to the tracking function of the MSC)

1: when typing SMS messages, it turned out that keys reacted too fast (should be slower to enable to get to the 2nd-4th letters on the individual keys).

1: there should be several models of the MPH in order to adapt to the special needs of each disabled person.

1: the carrying aids stigmatise!

1: MSC should use a different coloured dot (on map) for each user

2: the dots on the MSC map should indicate the direction of the user (the mass of circles and dots is confusing).

1: User is not sure what happens when more SOS-calls are received by the SC.

1: User states that the MPH will especially be useful in the event of technical difficulty with the wheelchair, because user fears to be stranded when wheelchair breaks down.

2: User would need a MPH only as basic telephone and for the SOS-function, and would not need any additional GSM functionality.

2: Would want the MPH attached to his body -- either on the belt, around the neck, or on the wheelchair. (remark: Mounting kit for wheelchairs does not fit.)

1: Due to a severe hearing limitation only the SMS functionality of the phone would be of use.

2: Due to severe spastic conditions both hands the user would need a special holder (hand-to-phone) in order to hold the MPH to his ear. Also, when carrying the MPH wrist carrying strap would be needed.

2: only SOS functionality needed. SOS-button should be bigger and more central (for this kind of application)

4: Buttons (especially SOS) should be easier to press, because user's hands are weak, should be more protruding.

1: The 'fall-back' numbers after the first SOS-number are rated extremely useful.

4: Voice operation would be very useful.

4: Hands free operation should work properly (otherwise phone would be useless for this user)

1: would need a typing stick to press the buttons

1: Due severe hearing loss, needs strong vibrator and hook-on; SOS siren needs to be louder in order for him to hear whether it has been activated accidentally.

1: Would need some external device that triggers the SOS function in case of sudden and violent epileptic attack.

Of great concern to this group was the price of the MPH and services. They all receive only few pocket money amounting to ca. 80€ per month and fear not being able to finance the purchase of a MPH and services.

For some users the possibility for very special adaptations have to be foreseen to make the phone accessible by them.

Service Provider contacts:

Johanniter:

Service: response to emergency calls by paramedics or nurses

Technology: so-called 'Base-Appliance' worn by customers. An SOS button sends a radio signal to an adapter connected to the telephone plug-box in the home. The signal is then sent via the normal telephone network to the main centre in Berlin. The 'Base-Appliance' of all the paying customers are registered in the main centre, so the personnel knows from whom the emergency call is coming.

Cost: the appliance itself cost between 350-500€, but one can rent them for 17€ per month. That price includes installation of the receiver (at the telephone plug in the home) and the service.

Customers: there are currently ca. 110 customers in the Potsdam area

Red Cross:

Service: same as above

Technology: same as above

Cost: same as above

Customers: ca. 30 in the Potsdam area

Malteser:

Service: same as above

Technology: same as above

Cost: for customers in the category „care level I“, the appliance is free of charge. For 17€ per month one is covered for emergencies. A fee of 33€ per month provides a customer with more service. For example, care takers will come to pick up someone who has fallen out of bed (a non-emergency).

Customers: ca. 1,500 in Berlin/Brandenburg (Potsdam belongs to the province of Brandenburg).

Diakonie:

Service: response to emergency calls by nurses

Technology: normal telephone

Cost: no cost, since customers are all covered by the national insurance company

Customers: ca. 80 in-and-around Potsdam

The Diakonie was selected because it is a large, well-known and established care-taking institution. Yet, it does not offer the technical rescue service that the other service-providers do. The reason for this is lacking financial resources.

As with all the other demonstrations, the principle functionality and idea is very much appreciated. There is also a great interest in getting a device like the MPH or the MSY with its services but the present device is too heavy, big and unstable.

1.4 Service Conference at KOT

Additionally to the demonstration activities at all test sites on March 7th, 2000 a public demonstration at the Kotiranta test site with participation of user organisations, service providers and governmental institutions was organised. The conference had the following schedule:

- An introduction phase giving background information on the MORE project and the purpose of the conference. A video explicating the intended use of the MORE system was shown.
- A demonstration was given that explained the use of the most important functions: Power ON/OFF, SOS with localisation, making a call, receiving a call.
- The different aspects of the benefits of the MORE system for D&E users, their service providers, telecom operators, social funding etc. were introduced. Reports with details for the different interest groups were distributed.
- Several MPHs were given to persons with support from MORE staff to try the basic functions
- In a discussion round the impressions on the MORE system were asked.

A press release with wide distribution was made. An extended invitation was given for service providers to attend the Kotiranta Service Conference. The press release caught a lot of attention in Finland, both in many radio stations, daily newspapers and weekly professional newspapers, with many discussions following the conference.

Many potential service providers were indeed interested. The main problem from service provider point of view was, that the system is in a prototype phase with a lot of instability in the equipment, and yet no commercial system is available.

This made the situation difficult for the service conference arrangers with just a prototype, which would not come to the market without major redesign.

The service conference is described in detail in WP8 deliverable D8-4.

1.5 Feedback from SAFE21 project

The SAFE21¹⁾ project is working on a range of products. Besides the control centre side of mobile alarm and mapping, SAFE21 develops a portable alarm trigger with speech/listen possibility, a deaf social alarm with text telephone, a social alarm information system, a telemedicine monitor and a multifunctional control centre. There are three trial sites: Northampton UK, iRv/Hulpnet NL and Barcelona ES. The SAFE21 project received several MPHs to be used as one of the mobile alarm devices in their tests and in turn provided the map display module for the MSC.

SAFE21 delivered the following comments:

The three SAFE21 trial sites experienced some difficulties with using the mobile alarm. However, the concept of mobile alarm is considered to be useful, and in the near future devices and services based on mobile alarm will appear on the market. Maybe localisation will be a feature of all mobile phones in the future, and probably the localisation will be based on different technical principles than GPS. The current mobile alarm can be considered as a "proof of concept", which is not a marketable product at this moment.

1.6 Conclusions

From all the demonstration results and contacts presented in short above, a high appreciation of the services planned to be offered with the MSY concept can be perceived. Both, the potential users and the potential service providers, expressed that they would be

interested in an application of MORE in the near future, given that the final product would be more reliable and functional than the current prototypes, and, of course, depending on the costs.

Starting with the next chapter the material contained in the public reports to interested groups is presented.

2 The MORE Project – an Overview

EU Project, Telematics Applications for Disabled & Elderly People DE3006

2.1 Project Summary

The project aimed at integrating the non-uniform group of disabled and elderly potential customers into the mobile phone users society for interpersonal communication. The GSM services have great potential for enhancing autonomy and quality of their life.

The main objective was to redesign existing mobile phones and simplify the user interface to meet the manifold needs of elderly and disabled people and make mobile phone services accessible for them.

A second objective was to realise an efficient access to emergency services, i.e. provide a foolproof and failsafe operating procedure and integrate GPS-localisation features.

A third objective was to provide interfaces to add-on equipment e.g. for hearing impaired: Text telephony awareness of public alarms, speech intelligibility enhancement, and link to hearing aids.

A specific objective was to provide interfaces to integrate results from TIDE projects SICONA and DEFIE, and to solve the severe interference impact of digital mobile phones on hearing aids.

The anticipated result was the Mobile Rescue Phone and System: The basic MORE-Phone being a mobile phone with integrated GPS, forming the 'application core' - with customizing features by optional multi-modal i/o add-ons. GSM standard infrastructure is used. Existing public and private service centres will be upgraded with computer mapping equipment and software.

User categories:

All conceivable user categories were integrated in the project from the beginning - via the test site partners in the 'MORE User Club'. They worked out the user requirements covering 'design for all' aspects and tested the demonstrators.

Approach:

The MORE-system contains and integrates GSM and GPS modules, and utilises GSM services and infrastructure, software-modules were added and a user interface was developed.

Benefits for the citizens and users:

By using the MORE-Phone elderly and disabled citizens can call for help or initiate rescue at any time from any place covered by GSM. In the emergency call mode the efficiency of rescue activities will increase remarkably due to precise localisation of the user.

Disabled and elderly people will gain general access to mobile telecommunications, and be able to enhance their ability for freer and safer mobility.

Support is provided for those European households/homes which take care of elderly or disabled persons.

Benefits for European Industries:

The MORE-Phone is part of an innovative and versatile product family which puts the European industry in the field ahead of international competition in assistive technology. The industrial partners intend to produce a first production run very soon after the project.

Contribution to EU Policies:

The project is user driven. The MORE-system improves the autonomy of life for older and disabled people, covering the various user categories with the basic MORE-Phone, thus meeting the 'ARTICLE 100A DIRECTIVE'. The consortium is cooperating with the EU project SAFE21 and uses results from SICONA and DEFIE projects. The rich experience of the work

done under the COST219 action and the INCLUDE project was integrated into the development process.

MORE directly meets the requirements of the EU's 4th Framework Programme, where consideration of D&E was a main issue.

The different Key Actions of the EU's 5th Framework Programme also include the needs of D&E e.g. KA1 "Systems and services for the citizen" of the 2nd Thematic Programme "Promoting a User-Friendly Information Society (IST)" addresses the development of services "for everybody" and in the preamble D&E are specifically addressed under "socio-economic needs". KA1.3 expressively deals with "Persons with special needs, including the disabled and the elderly".

Priorities of the KAs are defined for persons with special needs "to support autonomous living, social integration and participation in the information society", all of which are addressed by MORE. Cross programme action 3 deals with Design-for-all for an inclusive information society.

2.2 Project Workplan 1997 – 2000

The project was structured into 9 work packages (WP):

WP1 user interviews (130 users), expert interviews and design puzzle, literature

-> M1-1 table of preliminary user requirements specification

-> Universal Design and Iterative Design

Rating by percentage of votes from users, importance rating by experts, feasibility

-> M1-2 table of user requirements presented in D1

D2 Special issues of interference impact on hearing aids

WP2 D3 MORE system concept and block diagram

WP3 Hand phone optimisation D4,

D3-8 presents testing of solutions and update of M1-2

WP4 MORE chip set D6

WP5 MSC lab model & prototypes for verification D5

WP6 Verification & Redesign

MPH and TECOK prototypes for verification D9

Verification tests with users and experts, Redesign

Equipment for demonstration stage D10

-> M1-2 table of user requirements update

WP7 Final Verification & Demonstration

Final Verification tests

Demonstration

-> M1-2 table of user requirements update

D7-1 presents results, D11 Report to interested groups

WP8 Exploitation

Standardisation Suggestions D12, Specification for Redesign D13

WP9 Management

2.3 Project Partners

MORE is a pan-European research and development project that aims at integrating the heterogeneous group of disabled and older people into the modern mobile telecommunications society. MORE receives part funding from the European Commission's TIDE office, which is part of the DG XIII Telematics Application Programme. The remainder of the funding for this large project comes from the partners. MORE has cooperated with the social alarm project SAFE21 sharing the emergency call protocol and the MORE phone.

MORE main partners:

IMS (Institut für Mikroelektronik)	Stuttgart; D 70569	Germany
BENEFON OY	Salo; FIN 24101	Finland
SERPE IESM	Guidel; FR 56520	France
CSELT	Torino; I 10148	Italy
FORTEC (Vienna University of Technology)	Wien; A 1040	Austria
STAKES (National Research and Development Centre for Welfare and Health)	Helsinki, FIN 00530	Finland
IfADo (Institut für Arbeitsphysiologie Dortmund)	Dortmund; D 44139	Germany
Rigel Engineering	Brussels; B 1030	Belgium
EHIMA (European Hearing Instruments Manufacturer's Association)	London UK GU 7PX	United Kingdom

MORE User Club – test partners:

Kotiranta Service Centre	Joensuu, Fin 80101	Finland
Regione Friuli Venezia Giulia	Udine, I 33100	Italy
Deutscher Alpenverein	München, D 80997	Germany
Johanniter Unfallhilfe	Wien, A 1180	Austria
Oberlinhaus Berufsbildungswerk	Potsdam, D 14482	Germany
Kliniken Schmieder	Allensbach, D 78473	Germany

2.4 The Product and Service and its Application

The MORE product consists of:

- The mobile device worn by the user – the MORE Phone (MPH) – being a full **GSM** mobile phone plus
- A built-in **GPS** based localisation device and
- A **service centre** (MSC) to provide emergency, localisation, help and information, configuration, training and maintenance services to MORE phone users as well as maybe also other general health and care related services.

The MORE phone is:

- specially designed to the needs of D&E people and **configurable** to a high degree.
- It can be accompanied by **special accessories** like the MORE Hook-on for hearing aid users (TECOK) to allow them to use GSM telephony without disturbing interference.
- It offers a **flexible interface to assistive technology** like special keyboards or output devices

The MORE system provides:

- **Communication** regardless of time and place – thus integrating D&E into the rapidly increasing group of mobile phone users
- **Contacting helpers**, wherever the user is, by an easy to use emergency (SOS) call procedure.
- **Locating** of users. The service centre can send help quickly to the right place.

- **Access to data about users**, this information can save valuable time in case the user cannot communicate him/herself with the service centre.
- **Remotely activating a siren** and flashlight on the MORE phone to help find the user. Control over the MPH's built-in hands-free mode.
- **Localising themselves** or finding a route. The service centre can also be called for this service.
- **Limited area tracking**, warning the user, when s/he has exited an area defined as safe to him/her. Alarm to the service centre if the user doesn't return to a safe area.
- **Periodically checking** if the user is well. It has potential for reducing the costs in terms of reduced number of check visits.
- **External devices** e.g. for text or Braille communication, external audio, remote alarm in- and output.

2.5 *Work Within the Project*

The project first collected information on user needs and such has gathered a vast amount of knowledge about the requirements on mobile communication devices which will be available as valuable inputs for other projects in the form of design guidelines.

With the help of the above mentioned guidelines prototypes for a mobile phone were developed that fulfil the requirements on communication and emergency functionality in the project objectives combining GSM and GPS in one device. Tests with users verified the functionality and usability and backed the developed MORE concept. Not all features could be integrated into the prototype as originally planned, a redesign before commercialisation will address these missing features. The MORE phone prototypes were also delivered to the SAFE21 project. Complementing the mobile device a prototype of a MORE service centre including a GPS reference station was developed and tested with users. For hearing aid users the prototype of a wireless coupling device was developed and tested that allows to avoid the interference from GSM to the hearing aid.

During the project MORE was presented at several conferences and fairs with the developed prototypes but also in form of videos and speeches. Within the last months of the project demonstration activities like conferences, public demonstrations and publications introduced the MORE concept to the public and interested groups. Every test site had its own demonstration activities within the local environment of potential users and service providers, interest groups and local authorities.

A so called "Service Conference" in the Kotiranta test site was held on March 7th, 2000 as the final presentation of the project outcome to the public.

The developed prototypes will undergo a redesign step before being brought to market by the MORE consortium in the near future.

3 The MORE Concept

The MORE strategy can be summarised under the slogan “Mobile Safety for Mobile People”.

The MORE System:

The MORE project is a European joint effort to develop a complete mobile rescue system combining existing technologies into an efficient unified mobile system. The MORE system consists of:

- the MORE phone
- the private or public MORE service centres and referencing stations – these can be located at clinics, alarm centres, the Red Cross, Johanniter, etc. – even at a relative’s home
- the existing digital mobile telecommunications network (GSM)
- the existing Public Switching Telephone Network (PSTN), for example the public emergency calling centres in Europe, reached through dialling 112 in most European countries and mainly handled by the fire (or police, rescue) departments
- the existing Global Positioning System (GPS).

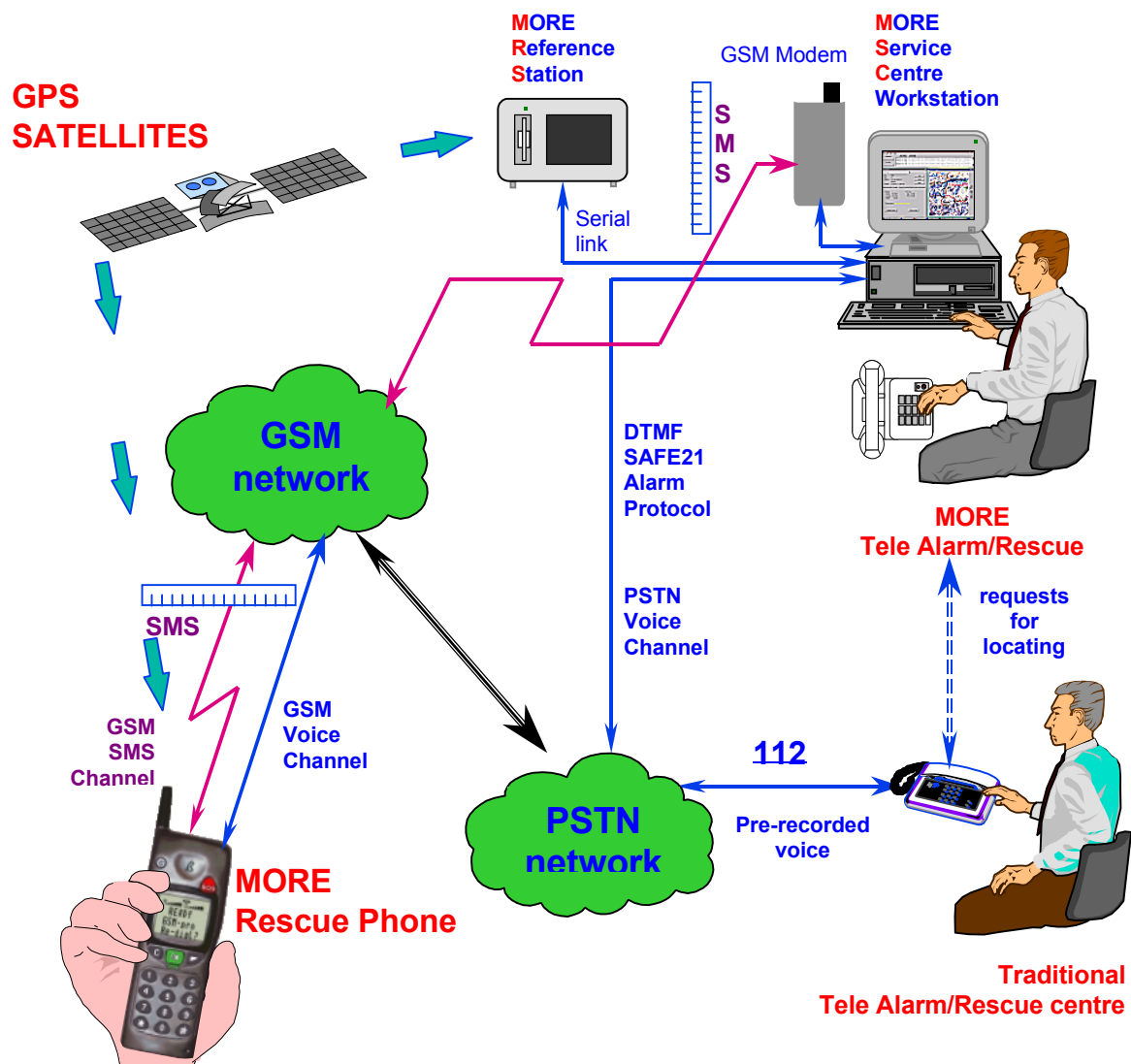

Figure 1: The MORE System

The MORE Phone:

The MORE Mobile Rescue Phone is a GSM mobile phone with special features. It is designed to facilitate efficient communication with the public and private service centres – and to enable people with special requirements to enjoy the benefits offered by modern mobile telecommunications. The MORE phone offers improved quality of life and security to a large number of special user groups. Essentially, it is a simplified mobile phone with an emergency alarm system.

From the user's point of view, the MORE phone forms the core of the whole MORE system. On the outside, the MORE phone looks like an ordinary mobile phone, with the addition of an emergency button for instant connection and built in speaker for hands free operation in an emergency situation. The simplified MORE user interface is designed with the needs of the older and disabled in mind.

The MORE phone can be easily adapted to the individual needs of a wide range of users because of its

- optimised modular design plus special hardware and software
- different customizing features
- optional MORE hook-ons, e.g. TECOK
- built in interface for specific add-ons, such as PC-based text telephones, external alarm sensors and future developments
- optional GPS locating feature, which will assist the public and private service teams in finding the user very quickly in an emergency situation.



Figure 2: 4-dial-key version and full key version

For the simpler 4-key version icons can be placed near the pre-programmed keys.
Both the key plate and the key mat can be easily changed.

MORE Mobility:

The MORE phone offers its users the same freedom of mobility as normal mobile phones, with additional features aimed at special user groups. This makes it possible for a lot of people, who would otherwise be confined to their homes and forced to rely on outside help, to gain independence and continue living a normal life much longer.

This creates a new challenge for the emergency alarm system – that of locating the mobile person calling for help. Traditional social alarm systems are located in homes, so the exact location of the person calling for help is always known. In the MORE phone this problem is

solved by an integrated GPS-based system, which enables locating the user during emergency or alarm calls, if authorized by the user.

MORE Security:

The MORE phone will give its users the security of knowing that help is available anywhere at the push of a button if required. At the same time, the MORE phone is a relief to family members and relatives. With the help of the MORE phone they can gain peace of mind in the knowledge that in case there is an emergency, help can always be easily reached – and, thanks to the built in GPS function, quickly and efficiently delivered.

For people having problems with speech and text communication, the MORE mobile rescue phone is the only possible way to call for help in emergency situations. Also, in an emergency, the victim can often be frustrated and panic, making it difficult to think and communicate clearly. In such a situation the easy-to-use ergonomics of the MORE can be decisive. The emergency button immediately connects the user with the service centre, and the built in GPS feature will quickly and accurately establish the location of the person in need of help.

MORE Services:

Among the EU population of some 370 millions, the MORE phone will give about 95 million older and disabled people the opportunity to benefit from better individual mobility and security. The growing proportion of older people in our society will mean a growing demand for services relating to their safety. This will increase the need to find ways to improve the possibilities of the older to maintain their autonomy for as long as possible.

The freedom of mobility and security offered by the MORE phone will serve this purpose in an efficient and cost-effective way. The flexibility of the system will allow easy co-operation and co-ordination between the different parties involved in service production, that is, private service organisations, authorities and even individuals.

The MORE system takes the concept of social alarms a step forward. In combining the flexibility and mobility of the GSM and GPS networks with existing alarm systems, it enables the production of more cost-efficient services for a growing number of people. The unique features of the MORE phone make it suitable for an incredibly wide range of users and situations, such as solitary workers, rescue teams, and so on.

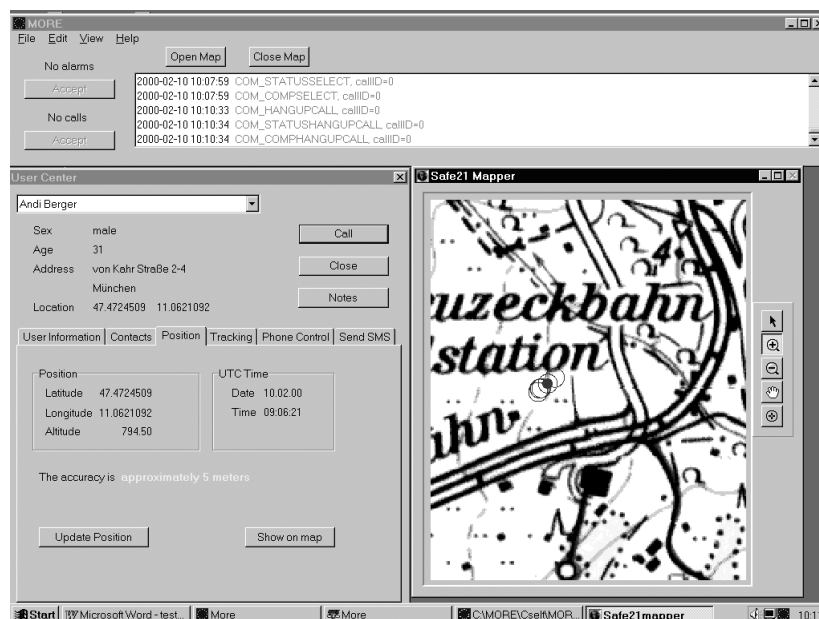

Figure 3: Screenshot of MSC user interface

On the MSC the top window shows the protocol of system events with time stamp. The left window displays the most important user data and localisation status and offers access to the database and the MSC and MPH functions. The right window shows the last user positions acquired (small circles) on a map.

3.1 User Background – Europe and Test Sites

In geographic Europe (around 800 Million people) there are about 100 million older people and 50 million people with a disability (77 million and 43 million people resp. for the EU, a total of about 95 million).

Within the MORE project an interview of 138 mostly D&E potential users of the MORE system (clients of service providers that act as test sites) was made.

Some results from the interviews are (comparative European figures in parenthesis):

- 82% (70%) of the disabled persons are above 65
- 10% (60%) of the persons above 60 are not disabled
- 80% of the interviewed have one ore more impairment (12%)
- 40% of the interviewed live alone (10%, 40% > 80)

Importance of functions:

Possibility for making alarm call easily	90%
Calling from anywhere	79%
Possibility for others to locate you	77%
Being reachable and receiving calls anywhere	63%
Possibility to locate oneself	52%
Possibility to find a route	45%

These figures show the high appreciation of the MORE features amongst the interview sample in which disabled persons were overly represented compared to overall European statistics.

A recent statistic from Austria, where the GSM marked has grown very fast in the last 3 years, shows, that currently older people are under-represented amongst the GSM users:

Age	%
12 - 14	28
15 - 17	55
18 - 59	56
>60	22

Figure 4: Percentage of GSM-Users per Age group
Source: Kurier/OGM 2000

These figures back-up the MORE focus to develop a solution for disabled and older people in the form of an easy to use phone together with built-in emergency call facilities.

3.2 User Needs

MORE WP1 studies confirmed the fact, that modern mobile phones are difficult or even impossible to use by elderly and disabled people. According to WP1, disabled and elderly people have several types of difficulties with ordinary GSM phones, which have not been designed to be easily usable by people with poor vision, hearing, memory, mobility or elderly people, who are not used to modern technology. The problems of these user groups in accessing and using the devices are elaborated in WP1 deliverables, and form one basis of user requirements specification.

WP1 studies also described in detail the possible benefits of the services made accessible via easy-to-use mobile telephony with easy access to communication and emergency services for the enhancement of independent living and safe-guarding of disabled and elderly

people both at home and outside home. The quantitative and qualitative analysis of the interviews led to the following line-up of functions that should be provided to the users by the MORE system:

- Communication functions:
 - Making a phone call by tapping, from phone memory or by redialling
 - Receiving a phone call
 - Sending data/SMS messages
 - Receiving data/SMS or voice messages
- Safety functions initiated by user:
 - Making an alarm call with special SOS key
- Safety functions initiated by service centre upon user request/consent:
 - Replying to a check call / periodic check function
 - Reacting to limited area tracking
 - Localising user
- Safety functions initiated by MPH
 - Reserved battery capacity for SOS
 - Making an alarm call on battery low
- Localisation functions initiated by user:
 - Requesting position (on MPH display)
 - Finding route to home location
 - Contacting service centre for localisation (on map in MSC)

These are described in detail in the WP1 reports, and summarised as requirements to the MORE system elements.

3.3 Transfer of user needs to design

The project internal format, in which user needs and requirements to be transferred to design were to be collected, was agreed in a project meeting held in Helsinki in May 1997. The agreed format was a table, where each requirement and need was described in relation to attributes, features and functions of the system. The format formed the basis of all future specification updates. On the basis of the requirements, technical partners established target specifications. These were used to create models and mock-ups of the product. The specifications were refined by collecting feedback from users. User comments were condensed for each attribute, feature and function and added to the specification table in a separate column. This way the designers could follow the acceptance of different functional specifications and any need for redefinition of specifications throughout the project.

The following table summarises the main user groups together with the main problem areas in the usage of mobile telephony for different impairments. The white numbers refer to technical solutions which are implemented by MORE system in order to alleviate the problems.

MORE phone and services are being developed to alleviate many of the problems mentioned in the table below by the following measures (refer to white numbers in table):

User class	Locate equipment	Locate commands	Identify commands	Use switches	Lift/hold device/handset	Use dial/numeric keyboard	Write on keyboard	Read text on screen	Select objects on screen	Receive audio info	Understand speech info	Receive acoustic alert/signal	Receive visual alert/signal	Insert cards/battery	Charging battery	Usage of speech input	Handle manuals/books	Read printed matters	Estimated number of people in geogr. Europe (Millions)
Blind	17	1	1	1 8		1	1 8	2	2				2 11	14	18		12	12	1.1
Partially sighted	17	1	1	1 8		1	1 8	1	1				2 11	14	18			12	11.5
Reduced vision	17	1	1					1	1				2 11	14	18			12	
Deaf – without speech	11									13	13	11				13			1.1
Deaf – with speech	11									13	13	11				13			
Hard of hearing	11 2									10 16	10 16	11							80
No speech																13			2.3
Reduced intelligibility																13			
Low speech volume																13			
Dyslexia			2 9				9 13	9										15	25
Language comprehension											9					13		15	
Intellectually impaired		3	3	6		6	3	9	3	9	9	9	9	14	18		3	15	30
Wheelchair dependency				4	4									14			15		2.8
Cannot use arms				7 4	7 4	7 4	7 4							14	18		15		
Cannot use one arm				7 4	7		7 4							14			15		1.1
Cannot use fingers				7 4	7 4	7 4	7 4							14	18		15		1.1
Cannot lift or push				7	7 4	7 4	7 4							14	18		15		
Reduced strength				5	7 4	5	5							14			15		22.5
Lack of co-ordination		6		6	7 4	6	7							14			15		
Reduced co-ordination				6	7 4	6	7							14	18		15		11.5

Table 10: Problem areas in telecommunication and reference to solutions/alleviation the MORE system can provide. Adopted from COST219 'Telecommunication for All' to the items related to mobile telephony

Problem areas:

	impossible		very difficult		Difficult		limited problems		no problems
--	------------	--	----------------	--	-----------	--	------------------	--	-------------

- 1) large labelling, big font, high contrast, clear shapes, tactile marking, clearly arranged keys
- 2) speech output, different tones, high volume speaker
- 3) easy to use MMI, reduced MMI
- 4) mounting kit
- 5) keys easy to press, low force
- 6) 4-dial-key version, funnel plate/grid
- 7) hands-free usage, lays fixed to tabletop, mouth-stick
- 8) tactile feedback
- 9) icons, symbols
- 10) clear sounds, speech enhancement in MORE Hook-On,
- 11) tactile ringer, visual ringer
- 12) manual in Braille, large print, cassette, training in MSC
- 13) SMS, text/data communication, Braille in/output, pre-recorded speech phrases
- 14) changes done by MSC, battery charged, not changed, well designed mechanical usage
- 15) online help (from MSC)
- 16) extra-loud volume, hands-free, remote antenna, MORE Hook-on for hearing aid users
- 17) add-on for finding the MPH, reminder to take MPH
- 18) supervised charging, capacity reserved for emergency call

Combining an easy to use GSM phone with GPS technology and add-ons makes it possible for all users regardless of their functional abilities to communicate with others regardless of time and place. It also makes it possible to contact helpers, the alarm- or emergency centre wherever the user is, not only from home or from public telephones. In order to make sure, that the helpers are able to find the user in distress, a localisation service has been developed, whereby the service centre can identify the caller and the location of the phone, and send the right help quickly to the right place. The service centre has a database of the users, and this information can save valuable time in case the user cannot communicate with the service centre. The service centre can also remotely activate a siren and flashlight on the MORE phone to facilitate the locating of the user.

During an emergency call the MSC has also control over the MPH's built-in handsfree mode. In addition, the MORE phone and services make it possible for example, for people, who are engaged in outdoor activities, to help them localise themselves or finding a route. Those people, who wish to localise themselves or find a route but cannot directly use the data offered by the phone, can call the alarm centre for this service.

The GPS functionality together with the MSC also makes it possible to offer new services and opportunities for people, who have problems with their memory or attention. The limited area tracking service warns the user, when s/he has exited an area defined as safe to him/her. This offers new independence to people, who have earlier been confined indoors or have to have a carer always on their side in the fear of them getting lost while outdoors. The periodic check call which can be received anywhere increases the independence of the user and frees him/her from the vicinity of a fixed telephone. It also has potential for reducing the costs of the social care unit in terms of reduced number of check visits.

The design of the MPH also includes the possibility to connect it to a variety of external devices e.g. for text or Braille communication, external audio, remote alarm in- and output.

MPH function blocks:

The product architecture was created from the selected product concepts by arranging the required functional elements into the following function blocks or chunks:

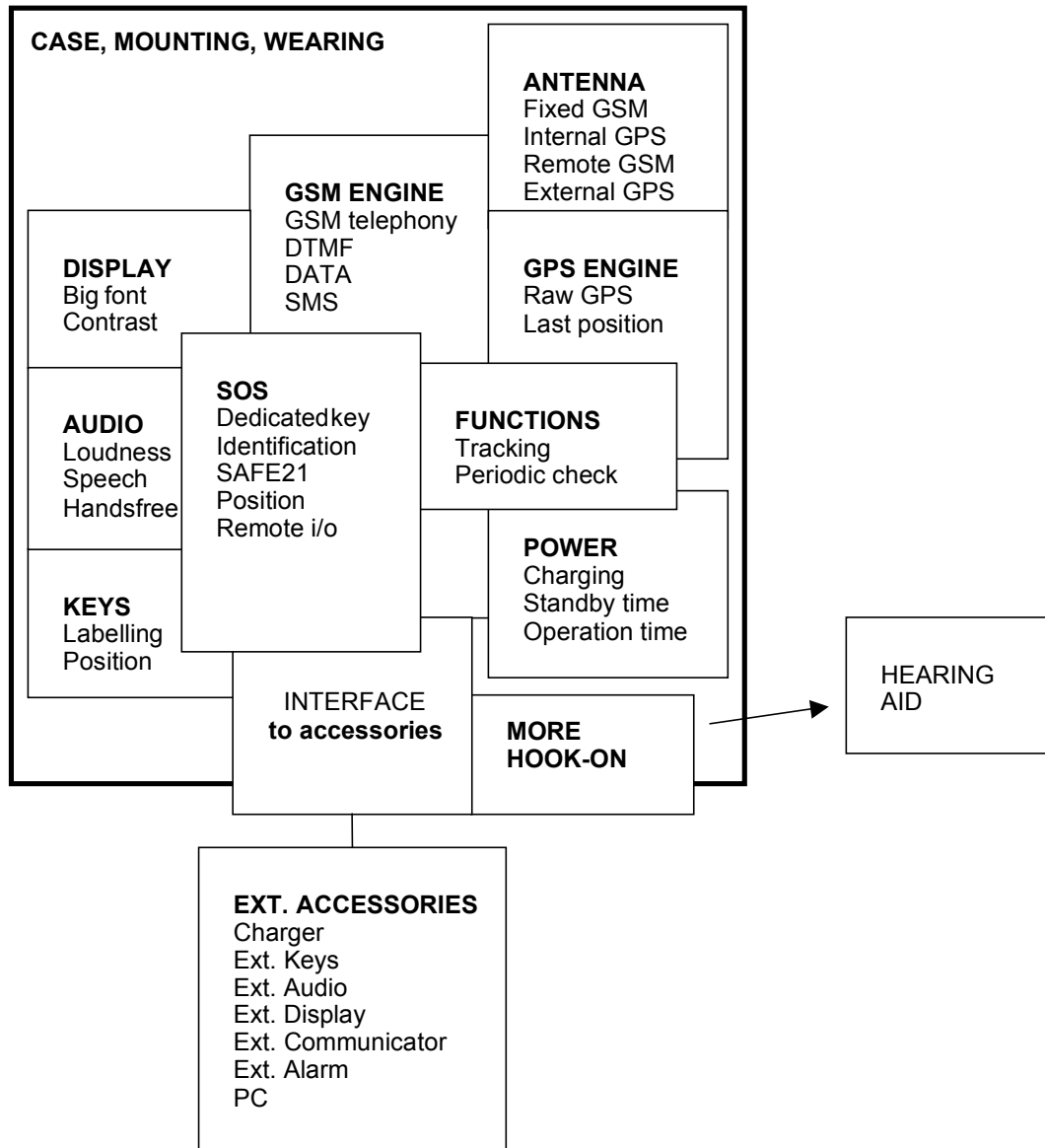

Figure 5: Main function blocks of the MPH

3.4 Implementation of Objectives

3.4.1 MORE MMI from User's View / Access to Mobile Communication

The user faces a single mobile interface to all MORE services:

- Communication
- SOS
- Localisation / tracking

Clearly identified function keys: position, shape, colour, label, tactile marking

Special simple keyboard layouts (4-dial-keys), also external input

Keys have low activation force and clear tactile feedback

Feedback to all user actions on display, speech output, acoustic signal, symbols, also external

Simple selections by user in each step to:

Cancel (C) operation

Accept/Go ahead (OK)

Request alternative, see more, go to next option (>)

Configuration of MMI can be made according to users needs:

Preferred input and output method

Parameters of interaction (speed, complexity of information)

Also remote configuration by MSC

Usable by hard of hearing and with hearing aid:

Extra-loud built-in amplification, hands-free w/o or with accessory

No interference to hearing aid from GSM by special MORE Hook-on

Intelligent built-in safety: reminders (switch on/off, to charge, take with) and automatic SOS actions

Interface to external aids

Connection to PC for e.g. text communication

3.4.2 MORE SOS Call from User's View / Access to Emergency Call

User presses SOS key (easy to find because of special shape, colour, tactile marking)

MPH switches Power On if not ON

Visual indication (bar) "SOS call – CANCEL?",

speech output, acoustic indication

Configurable time to cancel SOS 0-30sec

If user presses OK key indication that call is cancelled. MPH returns to previous state

Indication to user that call is started (if not cancelled)

Dial to 1st SOS number, retry 3 times, then next number of 3, loop

If not home-network: only 112

Indication to user that call is connected, call can only be terminated by MSC if MSC

Connection to SOS number (handshake if MSC)

Speech connection, SC operator speaks

MSC receives user data, MSC has control over MPH

User can press SOS again to let MPH speak his data to non-MSC

MSC can activate external alarm by light, sound or speech, hands-free, localisation

Connection until MSC terminates call at end of SOS situation

3.4.3 MORE Tracking from User's View / Access to Localisation

User asks for being tracked (by call to MSC or always active)

Permission to MSC to get position has to be activated

Definition of limited area in MPH if applicable

MPH does periodic localisation

If limited area: user is alerted to return to save area

Visual indication (bar) "Return to safe area!"

speech output, acoustic indication

configurable time to return to within limited area

SOS call is made if time limit exceeded

MSC gets control over MPH

speech connection to remind user to return to save area

If tracking at MSC: MSC operator can decide to call MPH to talk to user

3.4.4 MORE from MSC User View / Service Centre Implementation

Single interface to users for all services via MPH

Immediate availability of user data upon call

Control over MPH in case user is not able to react

SAFE21 compatible

Link to rescue organisation on button press

Logging of all relevant data

Graphical interface for user position on map with easy visualisation of movements

Central management of permanent user care and service for many users

MORE releases restriction in users movement

Automatic notification of system problems (battery low, no position for some time)

4 Advantages for D&E MPH Users

D&E, some 25% of the population, can benefit from the MORE system in the fields of **communication – localisation – safety** resulting in improvements in quality of life.

4.1 Hearing impaired

Around **80M** in geographic Europe.

This number can be subdivided into hearing impaired with

mild (20 to 40 dB loss)

moderate (41 to 70 dB loss)

severe (71 to 95 dB loss)

profound (> 95 dB loss)

mean audiometric losses.

Mild hearing loss (about **52M**)

need no hearing aids and generally only minor increase of speech-signal.

- **Powerful speaker**
offering additional 20 dB acoustic output over conventional GSM devices
- **High-quality hands-free kit**
offering a much improved quality by rather high output levels with low distortions and low leakage at low speech-signal frequencies

Moderate hearing loss (about **24M**)

are effective hearing aid wearers

- **Placement of the internal antenna** and an optional **external antenna**
increasing the distance between antenna and hearing aid to reduce RF interference
- The coupling between hearing aids and phones must be wireless and should offer sufficient noise-immunity.

Offering a wide spectrum of individual adjustments for individual optimisation of speech intelligibility by the **MORE TECOK** which provides:

A **dedicated method** which offers attenuation of interference to a level which does no longer disturb speech reception

Speech processing procedures for different degrees of hearing loss and level-adjustments to obtain best matches to different hearing aids (4 different hearing programs and various user-accessible adjustments) are easily selectable via the MPH menu

Enhanced **noise immunity** of signal transmission between hearing aid and the MORE TECOK is ensured by a modified inductive neck loop which can surpass the ETSI standard.

To optimise the benefit-to-cost ratio, different solutions can be envisaged:

- the “**simple version**”
filtering + level-matching
- the “**enhanced version**”
as before, yet in addition individual signal-processing
- the “**MORE+SICONA synthesis-version**”
containing additionally s-transposer plus extended RF-coupling and option for tactile replacement of selected speech features



Figure 6: MPH user with TECOK around the neck

Severe hearing loss (about **1-2M**) need an alternative to audible communication

- Additional to SMS **easy text-transmission** (comparable to the different text-telephone variations) is foreseen in the MPH concept. There is no standard yet for GSM (like V18). The phone will be “transparent” for data transfer to an external additional “intelligent” i/o device.
- For medium losses upwards, a ringing device in form of a **vibrating battery** is foreseen as alternative to high-level ringing tones. All tones contain high and low frequency components to ease recognition with different types of hearing loss.

4.2 Visually impaired

Around **12.5M** in geographic Europe.

This number can be subdivided into

Mild vision impaired (<20/40)

Low vision (<20/70)

Effective (legal) blindness (<20/200)

depending on visual acuity.

Mild or low vision impaired (about **11.5M**) need increase of contrast and size of letters

- **High contrast of display and labelling**
the colour of the body of the phone, keys and labelling chosen to provide maximum contrast.
- **Big font on display and labels**
Display with 3 lines with 9x8 font with a character height of 5.76mm. Labels on keys are increased to 4mm height on the numerals only version. Tiresias font for optimum legibility.
- The **display is coated** to reduce reflections.
- **Speech output**
information on the display can additionally be output by synthetic speech.

Blind or profound vision impaired (about **1.1M**) need alternatives to visual information.

- **Clear tactile identification of keys**
the shape and arrangement of the keys allows for easier identification.

- **Speech output**
the basic MPH functions are possible without reading the display. The display content is output by synthetic speech
- **External input and output**
an external keyboard and output device can be connected

4.3 Mobility of upper extremities, dexterity impaired

Reduced co-ordination of upper limbs about **11.5M** people

Reduced strength about **22.5M** people

About **1.1M** can not use their fingers

About **1.1M** cannot use one arm (in geographic Europe)

Reduced co-ordination:

- the **keys are concave** to help guide the finger
- a **funnel grid** can be clipped onto the keyboard to guide the fingers.
- the **response speed** of the keys can be adjusted
- a **4-dial-key version** with only 4 (staggered) dial keys with more distance or bigger keys that have pre-programmed numbers

Reduced strength:

- the **activation force** of the keys is lowered so less force is needed. The key mats can be changed to select the best characteristic of the keys.

Unable to use arms or fingers:

- input via a **single (external) switch** and scrolling. Control by speech input is planned to be implemented after a redesign.
- the device can be **operated by one hand** while lying on the table or while in the table charger.

Additional mounting and wearing support is provided.

4.4 Mobility of lower extremities, mobility impaired

Wheelchair users about **2.8M** people

About **45M** people cannot walk without aid in geographic Europe

wearing and mounting support provides access to the phone and ease usage.

4.5 Speech impairment

About **2.3M** people are speech impaired in geographic Europe.

Spoken SOS message to receiver of call

Text communication via SMS

Text (data) communication via external communication device

4.6 Cognitive impairment, language impairment and dyslexia

About **30M** intellectually impaired people

About **25M** people suffer from dyslexia

About **5.6M** people are language impaired in geographic Europe

Uncomplicated access by:

- **Simple MMI** with automatism
- reduced-dial-key version with big keys and **intuitive labelling**
- use of icons and pictograms

4.7 **Problems with consciousness, safety or increased risk**

For these people especially the safety functions are important:

- Periodic check function
- **External alarm** input from vitality sensor or shock sensor etc.
- Simple SOS call with user identification and localisation

4.8 **Usage Scenarios**

The following usage scenarios illustrate the benefit of MORE phone and services to disabled and older users. Most of them are based on actual cases from the users interviewed in WP1:

1. A 25 year old mentally impaired man, who cannot read, cannot enter phone numbers, has limited vocabulary. He lives in a medium sized town in a home for people with learning difficulties. He can move in familiar surroundings, but gets lost if he wanders off the safe area, if e.g. someone tempts him or if he gets on the wrong bus. The specialised health care pays for his phone. He would benefit most from **the 4-dial-key version with limited area tracking** service for following reasons:
He cannot enter full phone numbers, because he cannot recognise and remember numbers. The MPH has a photograph near each of the 4 pre-programmed dial keys. The 1st key is programmed to the home where he lives. The 2nd key is programmed to his parents. The 3rd key is programmed to his godmother. The 4th key is programmed to his sister.
4 keys provide enough space for labels and separation of keys while at the same time most flexibility whom to call.
He needs to be able to reply to calls from concerned relatives/carers.
He needs a speech contact to the service centre in case he crosses the line of the safe area.
He needs the speech output from the phone, because he cannot read the display.
The alarm, localisation and tracking functions allow him increased independence in moving around safely
He wanders by mistake to a strange part of town. Before he notices this and goes into panic, the service centre is alerted by limited area tracking of this incidence. He gets a phone call from the service centre carer who sees his position on a map, advising him to turn around to return to the safe area
2. A 75 year old woman, living alone in a small town, has rheumatoid arthritis, which affects the joints in arms and hands more than her legs. Her fingers have partly stiffened to bent position, partly the joints have been totally ruined by the disease. She can walk, but walking is slow and cumbersome. She would like to be very active in the parish, but the risk of falling and difficulties in using an ordinary phone or mobile phone limit here activities. She has an ordinary phone, but hurrying to answer it has caused her many risky situations. The advantage of a MPH over a senior alarm is, that she can use the same device for communication, alarm and localisation, also outside. She will pay for the MPH herself, if the social care office does not support it for her. She would like to get **the 4-dial-key version** of the MORE phone. Reasons for this selection are:

She does not make many phone calls herself, but several people call her every day, so an easy way of replying to phone calls is most important for her. Big OK-key and any key answering in MORE phone are thus important for her.

She would not have to hurry to the telephone, if she had the phone along at all times. Tapping and holding the phone on the ear are difficult for her due to the bent and deformed fingers so possibility for using the phone on the table or a neck strap would ease this greatly. MORE-phone offers both these features. The MORE phone does not rock and can be used on the table with the hands-free on, and there is a neck strap as an accessory.

She could also make calls by pressing one key at a time if they are far enough apart from each other to prevent tapping errors, to get in contact with the most important people in her life: her daughter, the janitor and the deaconess of the parish. The daughter and the janitor have a key to her home. In addition she would want the general phone directory inquiry to be programmed in the 4th memory place, because using heavy telephone directories is impossible for her and so she can benefit from the telephone operator making the connection for her.

The phone would also offer her the chance in case she falls to get help by a single key press. She is anxious to press the SOS-key, and therefore she would most likely press keys 1 and 2 (people she knows well) first to see, if they could come and help her. Only if nobody is available, she would use the SOS-key, which she would like to be routed to the nearby service centre, where she occasionally goes to have a meal.

The wrist worn wireless SOS button could be a valuable accessory for her if she would prefer to have the MPH in the table charger when being at home

The lady falls at home, hurts her hip and cannot get up by herself. As she fears that her hip might be broken she doesn't try to reach her daughter or the janitor but presses SOS, knowing that the MSC has her medical background information. She explains that she has hurt herself. The service centre carer agrees that her hip may have broken, and therefore contacts the emergency centre for an ambulance.

3. A 45 year old man with Parkinson's disease, who has at times powerful tremor. He is living alone in a little country town. He does not have any relatives. He likes to do walks around the town and surrounding countryside, but the sudden tremor attacks where he stiffens and cannot move his legs have frightened him to stay mostly at home. He has a normal telephone at home, and does not really feel he needs a mobile phone apart from the safety reasons. The social care office or health care system provides the MORE-phone for him. He selects the **4-dial-key version** for the following reasons:
He does not need to make ordinary calls from outside, but he needs the added security offered by the SOS-key.
He may not be able to speak when tremor hits him, and he needs the SOS message to be sent as a speech message to the general emergency centre
He wishes to carry the MPH on the belt and use hands-free function, because it is difficult for him to hold the phone and press the SOS-key at the same time.
The gentleman is going to the market place and he will get an attack of tremors. He presses SOS-key, but his speech is not very clear. The phone call will connect to an alarm centre, where if it is a MSC, staff can see his name and data on the screen and calm him and tell him that someone is coming to help him home. Because the speech is unclear, the gentleman cannot explain where he is, so the service centre localises him. If the SOS call goes to a non-MSA another press of SOS would speak the name and position of the man to the alarm centre staff.
4. The person is a 60 years old woman, who has become widowed last year. She has some kind of heart disease which will sometimes lead to arrhythmia. She is living in the countryside, where there is about five kilometers to the main road. She wants to have a full keyboard MORE-phone without letters for following reasons:

She wants to get independent of her ordinary telephone, with the full keyboard MORE model without letters and with customised menu, which is uncomplicated to use and similar to her phone at home

She spends a lot of time outdoors, and the MORE phone alarm and localisation features would increase her feeling of security both indoors and out.

Now she is near her home in the woods picking blueberries and does not have her medicine with her. She gets an arrhythmia attack and presses the SOS-key. The call connects to the service centre. She can communicate up to the point where the arrhythmia gets worse and she will lose consciousness. The GPS is important in this situation where the woman is unable to communicate to allow her to be found fast based on the last acquired GPS position.

5. The person is a 15 years old boy with muscular dystrophy . He is living with his family in the suburbs. He has learned very young to use an electric wheelchair. His mother is home with his younger sisters and father is at work rather near the home. He goes to the school together with his friends or alone. The health care provide him with different kinds of aids for helping his life and independence.

He would benefit from the full keyboard MORE phone with letters and all menu functions for the following reasons:

MORE phone accessories offer possibilities to attach the MORE phone to the wheelchair The alarm and localisation features of MORE increase his independence in moving around safely and reduces remarkably his parents worry about his health and safety The phone looks and operates like an ordinary mobile phone thus not stigmatising him.

Many of his friends have mobiles and it is very important to the boy to have same kind of mobile like others. It is very important as part of belonging to the group.

He can independently make calls with the built-in hands-free (nobody needs to hold the receiver for him) or hands-free kit and thus maintain his social relations.

The low activation force of the MPH's keys eases the dialling a lot for him.

It is winter time and he is going to the school alone. The road is slippery and he drives off the road getting stuck in the snow. He pushes the SOS-key and the call connects first to home, where mother answers. If mother does not answer, the call will connect to father and after that to the neighbour and in the last situation to the alarm centre. The GPS in this case is not necessary, because he knows where he is and can tell his place via the hands-free connection.

6. A person who has an age related hearing loss of 60dB and therefore wears a hearing aid can easily use the normal phone with his/her hearing aid set to the "T"-position where it directly takes up the electromagnetic field of the phone's speaker. This person would like to be more flexible by using a GSM phone while being outdoors but when trying out s/he experienced the annoying humming interference sound in the hearing aid caused by the GSM's operating principle.

As the MPH's built-in extra amplification of up to 20dB (125dB SPL with AGC) can allow people with an hearing loss of up to 70dB (MORE D2) to use it without hearing aid (protection above 100 dB for normal hearing) s/he will use this first possibly together with the hands-free accessory.

If amplification alone does not work the MORE Hook-On as a special accessory allows to couple the MPH's output directly to a hearing aid in the "T"-position thus eliminating the usual problems of interference and additionally offering easy control of the Hook-On parameters via MPH menu.

When this person obtained a MPH s/he also was recommended the MORE Hook-On that is attached to the MPH that s/he wears clipped to the belt. S/he additionally wears a small microphone and transmitter around the neck. The parameters for the Hook-On were adjusted by the service staff to a proper level in the MPH's menu fitting to the persons type of hearing loss.

7. A middle-aged person with reduced vision due to a progressive disease employed as consultant experiences increasing problems in usage of his/her mobile phone. S/he is no more able to read the display especially in dim light. As s/he gets aware of the MPH it becomes his/her premier choice in the full key version:
S/he benefits from the MPH's high contrast display with big fonts.
The clearly arranged keyboard with good contrast labelling allows him/her together with the tactile feedback from the keys to enter numbers without mistakes
Consistent acoustic feedback indicates the state of the MPH without reading the display
This person with the MPH is able to do his/her business again. If his/her vision will further reduce the MPH can assist him/her by activating the speech output for all functions.
8. A private service provider offers senior alarm services and general care services (housekeeping assistance, health care) to elderly and disabled clients. The present organisation requires to phone the clients at pre-defined intervals to check their situation and negotiate on the required services. This contacts imply that the clients be at their homes most of the time or at least at a certain known time. The director of the provider wants to make use of the MORE system for the following reasons:
Many clients already expressed that they would like to be more mobile and not bound to their homes for safety reasons as being now with their alarm phones
For the service centre it would be easier to be able to get in contact with the clients at any time, regardless of their position
Requests for care services can be easily negotiated individually from time to time without the need to keep to a regular schedule
Participation of the clients in every day life of their community, friends and relatives and communication with them can help them to stay agile and self-determined for a longer time
The possibility to make regular walks outside also keeps the clients more healthy and reduces time for rehabilitation after surgery or illness
The availability of a mobile alarm device allows the broadening of the services offered to new user types not yet covered without proportional increase of personnel resources
The association of user data with each call eases the management of user requests
The localisation functions of the MORE system help to locate clients in distress fast and with low effort. Necessary rescue operations can be started with maximum precision and efficiency
The built-in safety provisions in the MORE phone (programmed Power On/Off, reserved battery capacity for SOS etc.) ensure contact to and safe operation even for users with memory problems or low technological motivation
The flexible configuration for different disabilities allow all the users to be equipped with one type of aid instead of a variety of devices
The easy MPH MMI allows to lend devices to temporary users e.g. in clinics without the need for extensive training
In case of an SOS call the powerful hands-free function allows to speak to the user in distress even if s/he is no more able to operate the MPH. Also people passing by can easily communicate to the MSC without need to know how to operate the MPH.
Although the costs for the MSC and supplying a MPH to the users have to be considered serious the increased flexibility and safety for the clients and the higher quality of services can be used to address new user types that do not want to fully give up their independence. The higher efficiency and accuracy of emergency services helps to save both life and costs.

5 Fields of MORE Application

5.1 Provision of services

5.1.1 Support by MSC:

The MORE system is highly configurable to the special needs of a user. The optimum adaptation to the needs of a specific user demands some decisions to be made prior to giving the device to the user. Therefore the MSCs are equipped to help a potential user to choose the best suited MPH version (full key or 4-dial-key etc.) and to configure it properly

The data of the user (risks, medication, relatives) that will be stored in the MSC's database and the type of services and necessary agreements are worked out together with the user so in an emergency case they are readily available

The MORE concept allows the MSC to assist the user also further during the usage of the MPH by providing online help and remote configuration as well as additional relay services and maintenance management.

A MSC can be either a central institution for several individual MPH users, offering MORE services directly to them, or offering the MORE services to other service centres and only indirectly to their MPH users.

5.1.2 Telecom providers

To stay integrated in social life D&E need equal access to mobile telephony. D&E often face barriers in usage of the devices designed for able-bodied people. Mobile telephony also tends to become an important factor in work, so everybody needs access to such devices on equal basis. The MPH reduces barriers in usage of mobile telephony and enables a new group of people to participate more easily thus increasing the number of mobile telephony customers. The MPH will allow providers widening of their services to D&E customers.

5.1.3 Alarm call providers

Traditional alarm call services are restricted to the home environment because the alarm lines are either installed by direct wire or via a fixed PSTN phone line. Widening of services to mobile alarm provision together with locating services can provide new opportunities. The easy way of making an alarm call with the MPH together with the then triggered security mechanisms via the MSC will create a new quality of services.

5.1.4 Homes for the D&E

Monitoring of the position and status (either path tracking or limited area tracking and periodic check function) of people with high risk of unconsciousness, sudden illness, accidents or losing orientation can reduce costs for escort services, increase the users' quality of life and reduce the costs for search and rehabilitation because of faster localisation in case of distress. The possibility to read out the position on the MPH or get it via a call to the MSC will increase the feeling of safety in unfamiliar surrounding and such rise the willingness to go outside.

5.1.5 Visit and home care service providers

D&E people who live alone often choose to go to a service home because of safety and security reasons. Increasing their feeling of security with a simple method of calling help will cause them to longer maintain their independence and reduce the costs for care homes and care services. The frequency of home visits can be reduced if people are able to receive check calls also when outside their homes, also communication for negotiation of service needs will become easier— no visit is necessary if not needed.

5.1.6 Cost Reduction for Municipalities and Governments

The MORE services allow reducing cost for social services by permitting longer independence of people which would otherwise need to be sent to a service home, but also reduced costs for search and hospitalisation because of earlier rescue in an emergency case. To further investigate this, a study¹⁾ "Evaluation of the usefulness of MORE from costs' point of view" using tools developed in the PLANEC project was made. It describes 7 real cases, i.e. clients with certain service packages (current services the client receives, intensity & price of the service, the dependency category of the client) and evaluates which of the services in the current package can be replaced by using MORE including calculation of the costs before and during using MORE.

5.1.7 Relatives

For relatives of D&E people with the MPH it will become much easier to stay in contact with their people, even if there is not much time for regular visits. With the MPH they can be convinced that there is a possibility to call for help if needed from everywhere by just pressing the SOS button.

5.2 Application for Equalisation of Opportunities

With the rapid advancement of information society, it is increasingly important, that all people are given an equal opportunity to fully participate in the society on equal terms and manage their everyday life in e.g. work, leisure and studying.

In a world which increasingly depends on the ability to use and access to information technology this opportunity is not self-evident. The terms of developing modern technology are still often dictated by industry and there is a real danger, that disabled and elderly people are left out.

MORE phone and services are developed **with** disabled and elderly people **for** them to meet the needs of the most critical users. A product designed to be usable by these user groups is often adopted also by other user groups due to its better usability.

The MORE system is built to help in equalisation of opportunities for disabled and elderly users in many ways. Many of these are benefits, which cannot be directly measured in money, because the most important measure is the **improvement of quality of people's life**.

5.2.1 Application for social communication

All people have the same rights for communication. According to the EU-Commission's Green Book on mobile communication, close to 80% of the Europeans will use some kind of personal communication in the year 2010.

The increasing awareness of equal rights of citizens has awakened people to demand mainstream products and services usable for all. MORE phone offers disabled and elderly people **equal opportunities in accessing mobile phone services**. The earlier MORE reports (WP1, RFR) point to clear benefits of MORE in regard to the systems potential in increasing access to tele- and alarm services for different groups of disabled and elderly people.

The MORE phone can also be used with different Aids for communication. In 1996 a study undertaken by Christian Buehler for the European Parliament's research section (STOA) called THE INFORMATION SOCIETY, analysed the then active HANDYNET database. ISO No.21- Aids for Communication, Information and Signalling were the fourth highest (3354) after Aids for Personal Mobility, Furnishings and Adaptations to Homes and Personal Care and Protection. This expresses not only a significant existing market but also a significant demand.

5.2.2 Application for learning and work

With increasing independence, also opportunities for lifelong learning can be enhanced by MORE. Disabled and elderly people feel more safe in moving outside home, which can be a

major obstacle in starting to study. For distant learning, the same arguments hold as for teleworking.

All people also have a right to work. One opportunity which MORE can offer is the possibility for increased equalisation in employment by using the MORE phone.

Unemployment of disabled people is a big problem: If the unemployment in the society is 10%, over 70% of disabled people are unemployed.

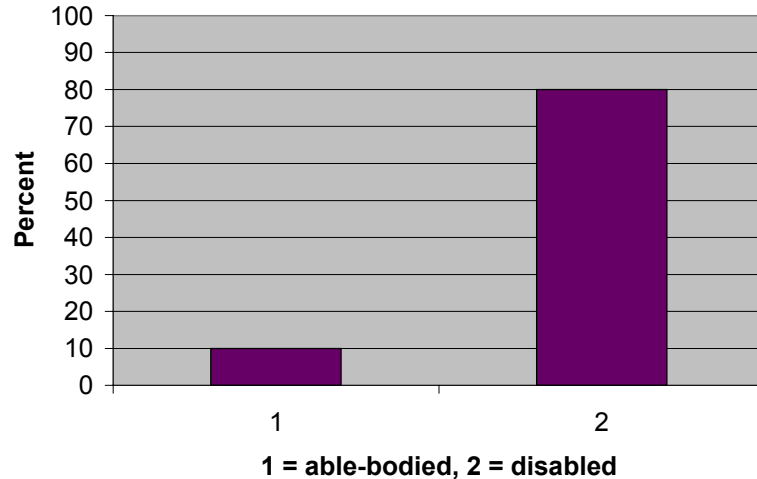

Figure 7: Unemployment rates of disabled and able-bodied (TWIN project)

According to the Ministry of Labour in Finland

- 22% of disabled people of working age (between 16-65) are in working life,
- 12,3 % do telework and
- 25 % of them telework regularly.

Telework means arranging work with information technology so, that the work can be done at least in part at home or outside the company premises.

In the EU TWIN project, teleworking as an issue in improving disabled peoples position in the labour market was clearly shown.

Mobile phones can be an essential part of the technology **enabling** teleworking. Current mobile phones are however, not usable for many disabled people. The MORE phone is therefore a clear improvement and opportunity for those people.

MORE phone and services also increase the independent and safe moving outdoors of disabled people, a prerequisite for many people for being able to go to their work place. A reduced need for someone to accompany a disabled person to work and usage of limited area tracking to safeguard the worker to and from work reduce the costs for the society. There are savings for the society for each disabled person, who with help of MORE can be shifted from unemployment to a taxpayer.

5.3 Application for safety and security

Elderly people who live alone or in residential homes are often very concerned about their safety accompanied by reduction in resistance to illness, causing progressive isolation.

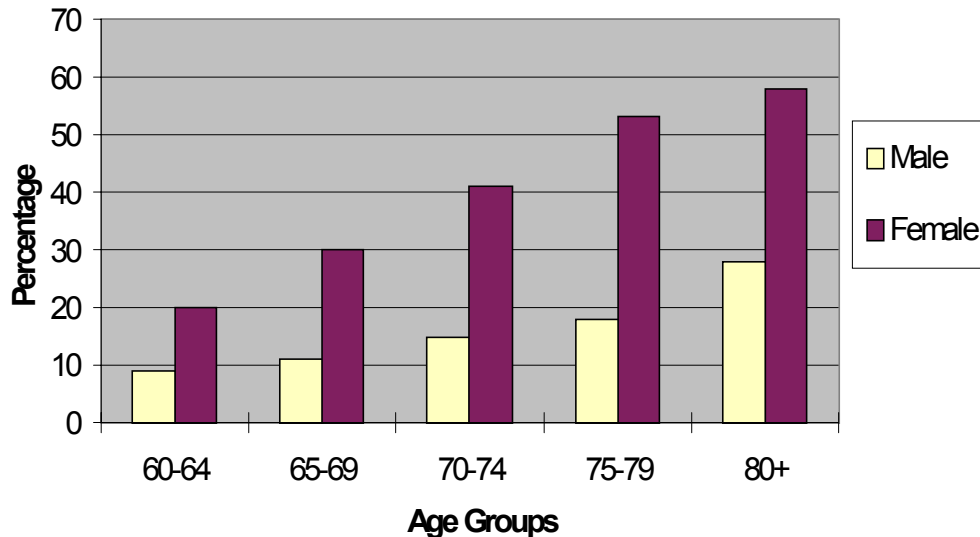

Figure 8: Proportions of older people living alone among all older people
 Source: Proceedings of the workshop on 'Elderly disabled and technology', DGV and DGXIII, 1994.

Safety and security related reasons have been the main cause for admitting people to homes for the elderly (ca. 80% of cases). When the emphasis of the treatment is shifted to open care safety and security problems experienced by these people need to be solved.

Care in the community is de facto and de jure policy across Europe. This includes ensuring a sense of security which is essential for social mobility and integration. Technical solutions, which help people live independently and safely at home longer, and which assist in quick administration of care in cases of emergency, are essential to help solve the dilemma.

According to the Viennese partner Johanniter Unfallhilfe, who are running a senior alarm service, about 50% of their 582 clients would prefer a mobile solution. Inquiries on trade fairs show interest rates of up to 80%.

One of the biggest problems in OECD countries is the change in the structure of population, the increase in the number of chronically ill people, and at the same time pressure to cut down on the expenses of social and health care and increasing home care. The need for increasing the safety and security for different user groups is clear.

The amount of elderly people is increasing in Europe. The figure below depicts two estimates for year 2020. Based on the findings of 12 national reports for the "1993 Observatory on Older People in Europe", it has been estimated that about one quarter to about one third of those aged 70 and above in the EC have health problems and accordingly require some sort of assistance in the ordinary activities of daily life.

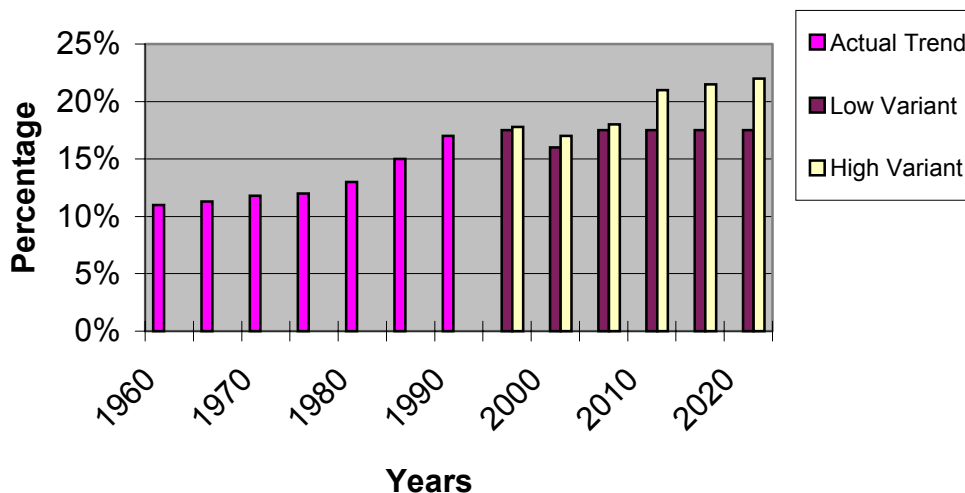

Figure 9: Increase of older people > 60 years, who are aged 80 and over between 1960 and 2020
 Source: Proceedings of the workshop on 'Elderly disabled and technology', DGV and DGXIII, 1994.

Other studies have shown that the proportion of disabled elderly begins to grow consistently after the age of 75. This means that it is the very old who are more likely to be disabled and in need of assistance.

5.3.1 Increasing accessibility of alarm and emergency services

In principle, all telephones are emergency phones. However, not all of them can be configured to meet the needs of disabled and elderly users to be able to easily alert help by simply pressing a button – even if the phone is switched off.

The need for increasing accessibility of alarm and emergency services was clearly stated in WP1 reports as means for increasing feeling of safety and security. The feeling of safety is a sum of several things.

Users interviewed in WP1 reported reasons for being concerned about safety like fear of sudden attack of illness, fear of external threat like fire or violence and fear of loneliness.

In 40% of alarm calls, the reason for the call was illness or accident, in 25% fear and in 35% other reasons. (MORE deliverable D1-3).

5.3.2 Reducing Fear of Illness

One of the biggest group of chronic diseases is circulatory diseases. They alone cost the industrial countries 10% of the health care expenses.

Another growing problem is Alzheimer disease. According to the Finnish Ministry of internal affairs in Helsinki alone, the police estimate, that there is at least one search per week, sometimes daily requests to search for people, most of these are elderly with memory problems.

The MORE phone offers increased safety for the users but also for relatives and carers, who can be relieved in their constant worry of a disabled or elderly person living alone.

5.3.3 Reducing Fear of Accidents

The Vienna Senior Health Report 1997 states that 28 % of the Viennese seniors have at least one accident a year, about 20 % are injured in that, 16 % must get outpatient and 6 %

inpatient treatment. The majority of the accidents happen in the flat (57%) and as pedestrians (37%). 93 % of all these accidents are falls.

The MORE system features make it ideal for many people at risk of these accidents. The SOS-key can be used to easily call help to the correct location. If the user is unable to use the phone, a motion or shock detector can start the alarm automatically.

5.3.4 Reducing Fear of Violence

Apart from fear due to illnesses, there is growing fear of violence experienced especially by women, elderly and disabled people, which has been revealed by different studies and confirmed by WP1 results.

In an international study (1996) covering UK, Northern Ireland, the Netherlands, Switzerland, France, Finland, Sweden and Austria,

21% of people reported being worried about being attacked when moving outdoors at night, and

27% of people are afraid of burglary.

The amount has been growing steadily from year 1988. Elderly people were above average worried about moving outdoors after dark. Elderly women were worried especially about robbery.

MORE phone can be beneficial for people afraid of violence in many ways. For example, pressing the alarm key activates a sound signal, which can deter the attacker. If the attack takes place, the MORE phone can automatically start an alarm with its position detector. Also the user can summon help easily into the correct location by simply pressing the alarm key.

5.3.5 Reducing Fear of Loneliness

Loneliness is an increasing trend (for complicated reasons) which militates against care in the community and is a factor in feeling of insecurity and anxiety to people. According to D1-2, up to 50% of people over 80 live alone, which increases the fear e.g. of not getting help in case of an emergency. The number of older people who feel lonely in the EC varies considerable between countries, from the 5% of Denmark to the 36% of Greece. (Source: Eurobarometer Survey)

5.3.6 Increasing Awareness of Warning Signals

Alarm systems range from simple alarm clock to sophisticated burglar alarms and national warning systems. Their function is to draw attention to the fact that something is happening and inform about the incident to direct user actions. The MPH can be used as an alerting device, which is connected to the home environment control system. The service centre can also send a message in case of a national alarm.

5.4 *Application in social system*

5.4.1 Savings due to early care

Even modern technology can not prevent accidents or attacks of illness. But it can assist in managing the correct help to be sent to the place quickly and efficiently. The figure below depicts the potential **savings of the early care**. With MORE alarm services, user can activate the alarm call, or it is activated, if the user's position is suddenly greatly altered. Also the alarm will go off, if the user does not react to a check call. With MORE localising facilities, the time-consuming search of the user becomes unnecessary and in most cases the correct help can be sent directly to the place of the event thus dramatically reducing the time needed for locating the user and starting the treatment. The user does not have to suffer in vain. With early care the society can **save up to 90% of the rehabilitation and treatment costs**. It has been estimated, that care received during the first hour of the accident or seizure reduces the damage into the body tissues dramatically.

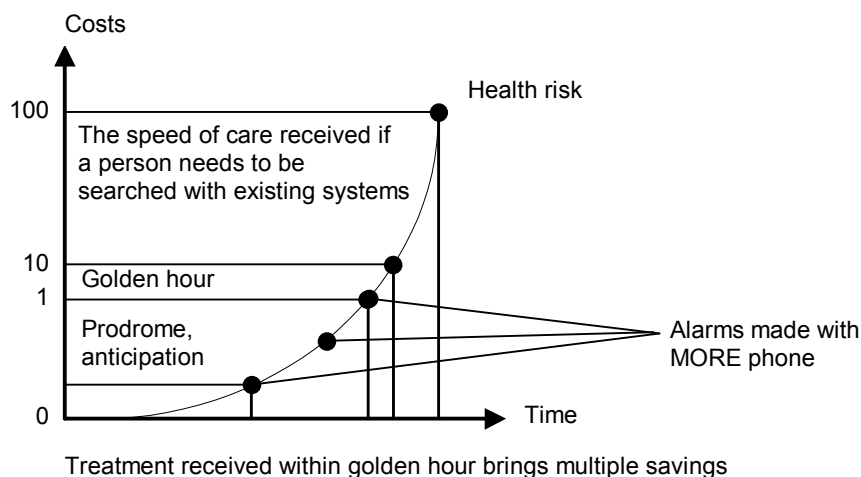

Figure 10: Costs vs. time for early care

5.4.2 Reduced need for home care

With an automatic check call system, the user does not have to be bound to home to reply to calls or visits. Working time of carers can be saved when s/he does not need to go to check just to find out, that the user is not at home. In many situations, where the user has previously needed escorting services, s/he can now manage independently by limited area tracking facility. The remote configuration possibilities reduce the need of professional technicians to visit the user or the need for the user to come to the specialists. Much of the users anxiety can be relieved, when s/he can always easily get in contact with the carers. Also carers worries can be relieved, when they know, that they can always get hold of the user.

The MORE phone can also **replace the devices** used today in home care of elderly and disabled people. The MORE phone has all the benefits of fixed **alarm phones** with two remarkable advantages: it is a mobile device, the user is not bound to home and it is a smart, ordinary looking telephone, which does not stigmatise the users, the ground with which ordinary alarm phones are often denied by elderly and disabled people.

5.4.3 Reduced institutionalisation

Often the early care **reduces time for hospitalisation**. Another clear benefit is the possibility for the users to **stay safely in home care for longer**. Annikki Korhonen, a leading adviser at STAKES for services for elderly people, estimates, that the MORE phone and related services can help elderly persons to stay at home and maintain their independence up to 6 months longer.

6 Design considerations in MORE

6.1 Design considerations for the MPH function blocks

- Mobile device implies severe limits on size, weight and power consumption
- Demands of one user class conflict with others
- Strictly specialised design might stigmatise as being disabled

The MORE project implemented "Universal Design" and „Iterative Design“:

- maximum of different needs are fulfilled in the basic device
- flexible concept and interfaces allows extension and adaptation:
4-dial-key version and MORE Hook-Ons
- possible solutions were continuously tested with users

6.1.1 Body

Physical parameter limits for size (space between ball of thumb and bent fingers):
width 6cm, thickness 2-3cm

Length of phone is given by distance between ear and mouth at about 16-17cm, shorter device needs more sensitive microphone and increases background noise.

Weight should not exceed 200g for some people with reduced strength of the arms

Design tests with wood models revealed (according to MORE deliverable D3-8) :

- Medium size not too small and not too big
- Universal design, not stigmatising
- Good fit into hand, non slippery
- Can be operated by one hand lying on a table and in charger
- Weight less than 200g with GPS
- Wearing and mounting support

(The prototype for verification does not meet the size and weight requirements with its size of 62x158x41mm at 360g. A redesign with new technology is needed and will be done for the commercial device.)

6.1.2 Keys

Most specifications for keyboards deal with fixed devices (standard phones, PC keyboards or kiosks) and demand rather big keys not feasible in a mobile device.

- Width of the body for standard key pad with 12 keys
- Three keys have to fit into the width of the phone of about 60mm
- Distance of about 5mm between the keys, distance to the left and right border
-> Maximum key width is given at about 1cm
- Key top should be around 110mm² (ISO 9241-4).
- Labelling of the keys has to provide good contrast to the key material.
- Reduced activation force of not more than 0.5-1N (50-100p) for people with reduced strength

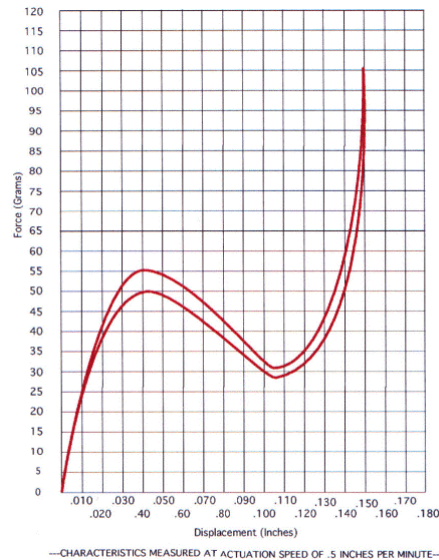

Figure 11: Typical foldback characteristic of keys

- Clear tactile feedback from activation (foldback characteristic)

Design solutions found (see deliverable D3-8):

- Keys shaped like a rounded triangle to save space at sufficient size for good separation between each adjacent 4 keys.
- Concave key tops
- Tactile marking of keys (dot on '5', SOS)
- 4 pre-programmed (staggered) dial keys as an optimum in providing both different numbers to call and clear separation of the keys
- 2 bigger pre-programmed dial keys easier to hit with space for labelling and resting fingers
- A grid clipped on the keyboard to guide the fingers to the keys (funnel plate) can be attached.
- Key version without labelled letters and bigger numerals
- Key height and movement of 1-2mm is sufficient according to tests
- Activation force and characteristic can be changed by replacing key mat
- Splash proof sealing of keyboard
- The control keys operate as follows:
 - The "C" key is used to cancel/correct an operation
 - The trapezoid "OK" key accepts/activates the option presented in the bottom line of the display
 - The ">" key leads to further options or to the next menu item
- The control of the speaker volume is done by two keys on the right side of the MPH, these keys can be used also to scroll through the menu.
- Operation is possible with a single (external) switch and scrolling options
- External key input from special devices

The implementation of speech input, although not considered feasible within the project because of challenging limits in size, weight, power consumption and computing power, is foreseen for the final commercial device with new chip set.

In the production device different key characteristics will be available to best fit the users' needs.

6.1.3 Display

The design of the MMI foresees three lines of information on the display.

- Big high contrast display
- Anti-reflection coating of display window
- Bottom line directly associated with the action of pressing the OK button
- Top line displays a title ore status information
- In the middle line additional information or parameters can be shown
- Lower case letters with fixed spacing are used
- Font size is maximum 9x8 pixels with 10 characters per line with a character height of up to 5,76mm on the current display (Teresias like font)
- Above the title line the usual symbols for different phone states can be displayed
- Complexity of information follows MMI type
- Symbols instead of text to further simplify the MMI for people with reading or cognitive problems
- Display output available via the interface connector to external devices
- Speech output for the display contents

6.1.4 Audio

The audio output of the MPH has to consider especially people with hearing problems. A special MORE Hook-On (TECOK) with wireless coupling to hearing aids to eliminate the interference from GSM has been developed.

Design considerations for D&E:

- consistent tone and speech output additional to display
- tones contain both high and low frequency components
- +20dB increased volume for hearing impaired users
- builtin loud handsfree or external handsfree kit
- antenna distant from speaker, also external antenna to reduce interference to hearing aids
- MORE Hook-On (TECOK) for hearing aid users with inductive coupling and adjustable parameters
- text communication interface to external devices for profound hearing loss or lack of speech
- vibrating battery for haptic ringer

6.1.5 Power supply

The battery package needs to ensure a standby operation of the MPH of 48h (Power on, no function active), including tracking or periodic check of at least the time for 4h and an active time while making a call with tracking on of at least 1h without need to recharge.

The battery management ensures that a certain percentage of the battery capacity is reserved for SOS calls and below some level an automatic SOS call is triggered. Full re-charging is possible in about 1h . To reduce the weight of the MPH a Lithium-Ion battery will be used in the commercial device. The battery can also provide the vibrating ringer. The implemented mechanism of changing the battery has been tested with good results (see delivery D3-8). The MSC supervises the age and function of the battery and replaces it if necessary. The MSC is able to read out the battery status remotely via a special command (especially during SOS calls).

Design considerations for D&E:

- intelligent battery management
- reserved capacity for SOS call
- automatic alarm if battery gets empty
- MSC can determine battery status

6.1.6 SOS call

The requirement to provide easy means for an SOS call demands a separate SOS activation button with a special shape (red triangle) to be easily identified.

Design considerations for D&E:

- Single button SOS call
- Operates from powered off device without PIN code
- Clear indication of status of SOS call and provision to cancel an unwanted call
- Configurable sequence of SOS numbers with fallback to public 112
- MSC has control over MPH during SOS call
- User data and position available to MSC
- User data and position also available by speech to non-MSC
- Compatible to SAFE21 alarm call protocol

6.1.7 GPS

The GPS unit provides raw position and additionally corrected position accurate to about 5m by differential correction from MSC. The position data is available both for the MPH user (on the MPH display and speech) and the MSC, in case of an SOS call also in the data and speech message transmitted then. The usage of GPS in urban areas with obscured view to satellites and multipath signals demands a state-of-the-art solution with short lock time and improved sensitivity. There are provisions foreseen to bridge gaps in GPS coverage like saving of last acquired GPS position together with a time stamp and optional other (additional) localisation methods like dead reckoning. A smaller, redesigned GPS-unit with more powerful functions and sensitivity increased by 20dB is planned for a redesign for the commercial device.

The MSC is able to ask the MPH's position (if agreed by user) without user intervention. (See deliverables D2-9 and D8 for details.)

Design considerations for D&E:

- User position on MPH display
- User position available to MSC
- Correction of user position via MRS in MSC up to 5m accuracy
- Tracking of user position by MSC
- Storage of last acquired position and time
- Fast start up and high sensitivity
- Additional navigation methods like dead reckoning will be tested
- The currently implemented GPS board will be replaced by an announced improved version (sensitivity, power consumption, size) as soon as its available.

6.1.8 Antenna

To fulfil the requirement to avoid movable parts the GSM and GPS antenna is fixed. For both MPH models a possibility to connect an external antenna is foreseen.

As a provision to reduce interference with hearing aids (either with fixed or external antenna) the GSM antenna is located as far away as possible from the speaker of the phone and thus from the ear (and hearing aid) of the user.

Design considerations for D&E:

- Fixed antenna distant from hearing aid to reduce interference to hearing aids
- External antenna possible to further reduce interference

6.1.9 Functions

The MPH provides the standard GSM functionality like that found in most other GSM phones.

The menu is configurable in its complexity and speed to fit to different users' needs and abilities. An easy to access phonebook memory is implemented. The basic call operations are possible without using the display. All output on the display is available also as speech and external. The operation provides automatism in dialling and accepting calls to make operation easier for people not used to mobile telephony. The user can determine his/her position on the MPH's display with or without position correction from a MSC. Together with a MSC the special functions to make an SOS call, to track the users position (also within a predefined area), to periodically check the response of the user and for remote configuration of the MPH's settings are implemented. The last security relevant events are recorded in the MPH's internal logfile.

Design considerations for D&E:

- Standard GSM functions, easy to access
- Configurable complexity of MMI
- Easy to access phonebook memory
- Automatic dialling and accepting functions with default area code
- GPS localisation function
- User position tracking
- Periodic check function
- Remote configuration from MSC

6.1.10 MORE Hook-On (TECOK)

The MORE TECOK is a special MPH accessory providing a wireless connection of the MPH to a hearing aid. It is directly or via a cable attached to the MPH's bottom connector and allows further accessories to be connected via its connector. The microphone is worn by the user together with an inductive neck loop that connects wireless to the hearing aid. It complies with ETSI ETS 300381/IEC 118-4 regarding field strength of induction loops. The function of the TECOK can be controlled directly via the MPH's menu without the need for an extra user interface (programs "mild", "moderate", "severe" and "custom", microphone level and other special parameters). The output volume of the TECOK is controlled by the MPH's volume keys as usual. An improved version of the MORE TECOK with improved noise immunity that would need slight modifications on the hearing aids is under consideration (radio link without need for neck loop). The TECOK complies with the guidelines developed in the EU HAMPIIS project ⁱⁱⁱ⁾.

Design considerations for D&E:

- Inductive coupling to hearing aids without interference from GSM
- Adjustable parameters from MPH's menu

6.1.11 Interfaces

The display output and audio output is externally available for connection to external devices. Input is also possible via an external keyboard device. The interface provide a means for text/data communication from an external communication device or PC. The interface connector can be used to attach accessories like the MORE Hook-On or e.g. an interface to a wireless remote alarm button.

An interface to a hands-free set with speaker and microphone is provided. This could also be used to connect to hearing aids via electromagnetic coupling (cheaper, lower quality solution instead of MORE TECOK).

Design considerations for D&E:

- Keyboard input from external devices
- Display and audio output to external devices
- Possibility to connect special accessories like MORE Hook-ONS or wireless remote alarm button
- Interface to external text communication device

6.2 MSC overview

The MSC is a special service centre that offers emergency call, localisation, surveillance and other services for users of a MPH. It communicates with the MPH and it's user over a telephone channel. A general MORE Service Centre (MSC) is based on a number of MORE Graphical Workstations (MGW) connected to a shared database (DB) containing (at least) the data of the MORE phone users served by the centre. Each MSC will be able to send/receive SMS messages, to send faxes, to link to GPS reference station in order to correct GPS data coming from MORE phones (MPH) and to manage phone calls (alarms, etc.): commands will be issued using the MGWs.

This means that the main components of a MSC are (see Figure 12):

MORE Graphical Workstation (MGW);

Front End (FE);

Shared Database (DB);

links to GPS reference stations;

links to SMS service centres;

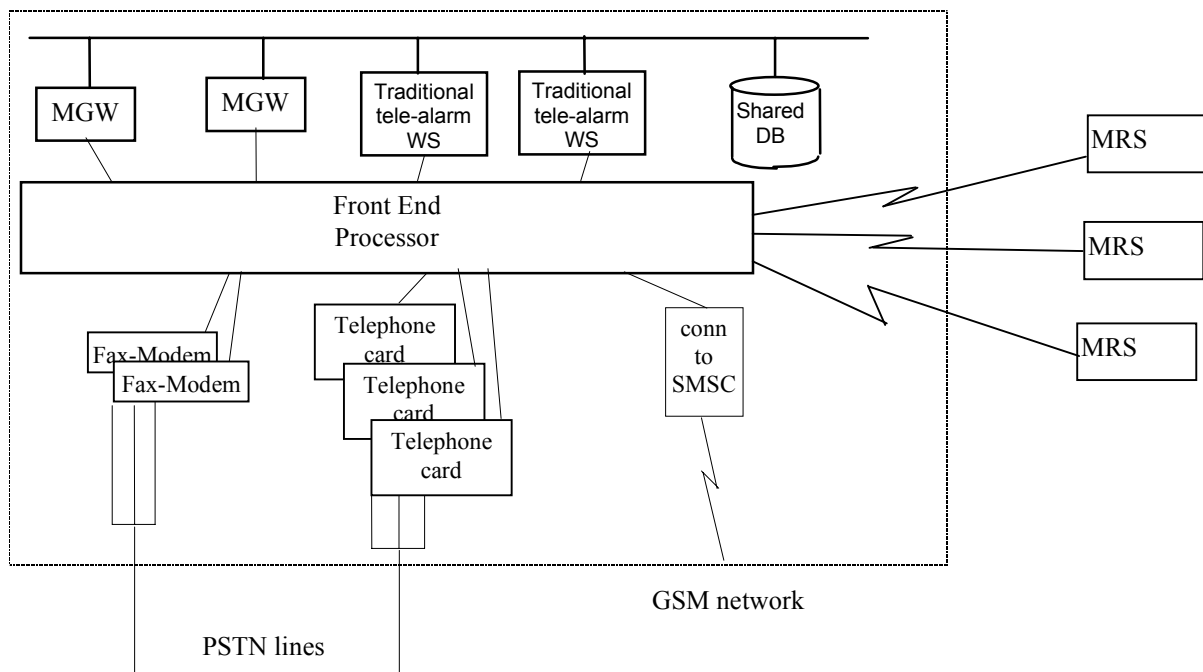

Figure 12: Architecture of a general MSC.

6.2.1 MGW

MGWs are the main components of a MSC: all commands and alarm management will be accomplished using MGWs.

Each MGW can be used by a single operator at a time because its shared usage by different operators is felt to be impossible in real alarm situations.

The MGW operator will be able to perform hands free voice communication with at least two lines at a time (e.g. one for communicating with a user in trouble, the second for communicating with a rescue team), to locate users in trouble, etc. A third PSTN line can be used (by a modem/fax card) to send faxes.

6.2.2 Front End

The incoming alarm calls from the MORE phones arrive to a Front End module at the general MSC through a number of PSTN lines with a single numbering scheme provided by the local telecom operator (it could be a Toll Free number and/or a nation wide unique number).

If different MSCs exist on the territory the Intelligent Network Services of the local Telecom Operator can be used to dispatch alarm calls, directed to a nation-wide (or even European wide) unique number, to the MSC geographically nearest to the current user location.

The Front End module will dispatch calls to the first available operator.

From this more general architecture the main function blocks of a MSC which can consist of one up to many MGWs and co-exist with traditional alarm infrastructure can be sketched as in figure 13:

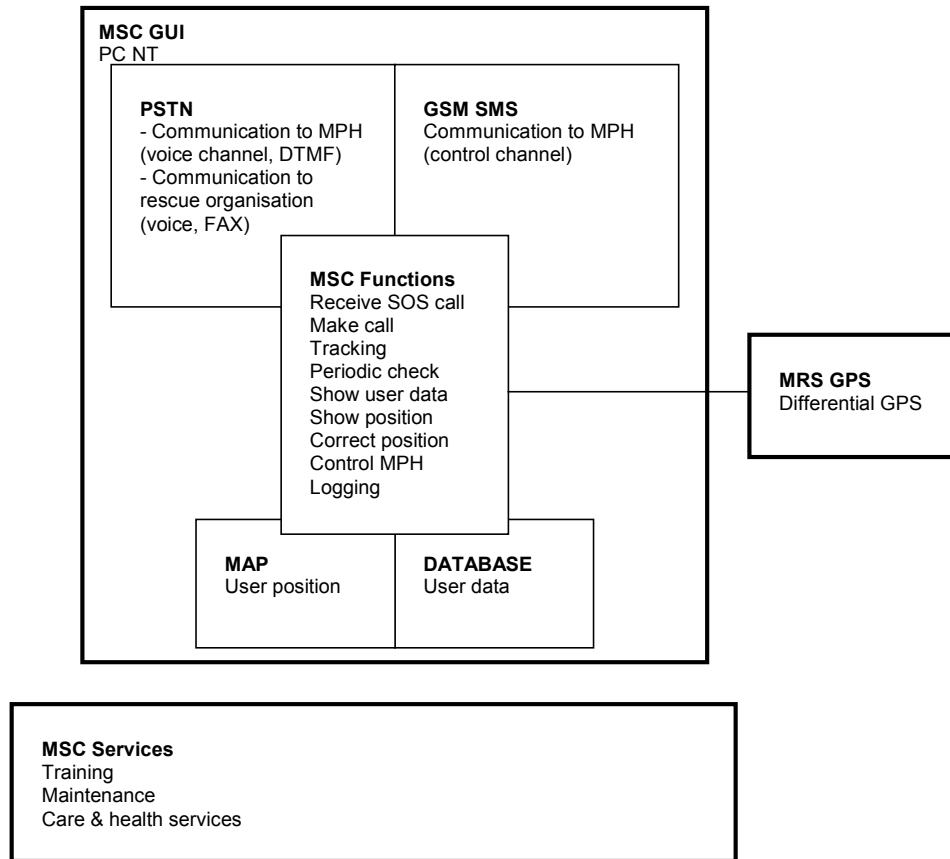

Figure 13: Main function blocks of the MSC

Possibly the Front End processor will be equipped with more incoming lines than the number of available operators. In this case, if a call is received when all operators are busy, an alarm should be displayed for all the operators on duty, and the call should be kept pending for a predefined amount of time waiting for an operator to become available.

If no operator becomes available during the predefined time, the call will be dropped in order to free the line and allow the MPH to possibly call a public alarm service. The Front End should possibly perform a first procedure to identify the user identity (through Caller Id from the network, or User ID from DTMF handshaking), and an alarm should be displayed for the first operator to become available in order to allow to call back the user (the availability of this function will depend on the features of the Front End processor that is possibly already present at an existing tele-alarm service centre, and should locally adapted).

If different MGWs and traditional operator workstation are present at a same service centre, it can be locally decided that a call is dispatched to a traditional WS if no MGWs are available.

6.3 Design considerations for the MSC function blocks

The MSC is a service centre for users of a MPH that extends the functions of the MPH by providing a specialised SOS call procedure with remote control of the MPH and user localisation on an electronic map in the MSC. In addition via its MRS it offers a Differential GPS position correction to users of a MPH thus increasing the accuracy of GPS positioning to about 5m. Besides these functional services a MSC is intended to provide configuration of the user's MPH, training in the usage of the MPH, online help for the usage of the MPH and assistance in maintenance of the device.

The MSC functions can be implemented on a single MGW (PC workstation) or on several MGWs with connection to PSTN, GSM and the MRS as well as possibly to a MSC intranet (see deliverables D2-3, D2-8 and D5.1 for details). In the following a MSC implemented in a single PC will be described. This is the configuration that will be used during verification and demonstration tests.

Design considerations for D&E and MSC staff:

- The MSC extends the MPH's functionality from just communications by offering additional security services to MPH users
- The MSC design is based on one or more MGWs as a single operator console
- The MSC can coexist with traditional tele-alarm infrastructure
- The flexible, modular concept of the MSC allows to use a variety of solutions for each main component
- The MSC supports the user in setting up the phone (remote configuration) and with online help

6.3.1 MSC GUI

The user interface of the MSC runs on a standard PC with the operating system Windows NT. It integrates all functions of the MSC into a single user interface. All states of the MSC communication and a connected MPH are displayed and can be controlled by selecting appropriate options on the screen. All events on the MSC GUI are logged into a database with timestamp and identification of the MSC operator (see deliverables D2-3 and D3 and D10 for description).

The interfacing to the other MSC modules like database or mapping SW is done via a special command layer (ACL) to keep the modules independent of the specific architecture.

Design considerations for D&E and MSC staff:

- The MSC GUI combines all MSC functions under a single operator MMI
- It communicates to other MSC modules via a flexible Abstract Command Layer (ACL)
- The MSC GUI makes it easy to handle parallel calls to user and rescue team.
- It presents position and user data together with different mapping functions.
- It provides an easy to use interface for handling the shared data base.
- Activating and handling (i.e. toggling) of calls with support by hyper-textual lists and pop up windows in an intuitive way

6.3.2 PSTN lines

The MSC is connected to the PSTN to receive the SOS calls from a MPH and for making calls to rescue organisations. The minimum number of telephone lines is 2 for each MSC workstation to be able to receive an SOS call and simultaneously connect to a rescue organisation. If an alarm call is pending and all MSC operator lines are busy the call is dispatched to the first operator available or dropped after a certain time to allow the MPH to call another (defined) emergency number. Several MSC workstations can share a pool of PSTN lines, within the MORE project only a single workstation per MSC will be used. The PSTN lines are also used for the SAFE21 compatible initial DTMF data communication with a MPH in case of an SOS call. If a MPH is identified the data communication is then transferred to the GSM-SMS channel where it is handled in parallel to the voice connection.

The control of the PSTN lines is via the standard Windows TAPI interface (see deliverables D2-3 and D5.1 and D10 for explanation).

Design considerations for D&E and MSC staff:

- The MSC is reachable via standard PSTN
- One PSTN line to the MPH and one to a rescue organisation can be used simultaneously
- A third line to send faxes is foreseen

6.3.3 GSM-SMS interface

The MORE specific control channel is established via SMS protocol to the MPH. This can be operated in parallel with the voice connection to the MPH. The GSM-SMS box is connected to a serial port of the workstation and controlled via AT modem codes.

Design considerations for D&E and MSC staff:

- The MSC can communicate with the MPH over SMS in parallel to the active voice connection
- MPH functions can be controlled by SMS during SOS
- MPH settings can be changed remotely by SMS

6.3.4 Electronic Map

The user's position can be shown on a map of the MSC region. An average resolution of the map of about 5m seems to be appropriate. The minimum data in the map shall be a street plan with street names and house numbers. Additional information layers can be added. The coordinate system of the map is typically WGS84, the same as for GPS. The position of the user is indicated within a circle that represents the maximum possible error in the coordinates displayed. For the tracking function several successive positions and the borders of a limited tracking area can be shown per user. For the limited area tracking the definition of the borders of the area can be made graphically on the map before being sent to the MPH. Communication to the map SW is via a Mapinfo interface (widespread map SW). This part of the MSC SW is provided by SAFE21.

Design considerations for D&E and MSC staff:

- The MSC has immediate access to user position and environment upon each call
- The route of the user together with notes (timestamps) can be visualised on the map
- Limited areas can be defined and supervised for users security

6.3.5 Database

Data for every MPH user can be stored to a database. This can, depending on the contract with the MPH user, include basic data, contact information, health related information. Each MSC can define the necessary data. The database can be shared amongst several MSC workstations. The database is connected via an ODBC standard interface (see project deliverable D2-3).

Design considerations for D&E and MSC staff:

- The MSC has immediate access to user relevant data (e.g. information on special needs or risks) upon each call
- Shared data base to allow access by all MGWs always up to date
- Relevant data can easily be forwarded to third party rescue organisations
- Integration of already existing tele-alarm data bases

6.3.6 MRS

This MRS GPS receiver delivers the differential GPS information necessary to correct the GPS coordinates from the MPH to about $\pm 5m$. The MSC SW sends the raw GPS coordinates typically via a serial link to the MRS and receives back the corrected

coordinates. The GPS antenna for the MRS must be located (outside the building) such that as many satellites as possible are in view. The MRS is designed to cover an area with up to 100km radius (accuracy decreases with distance). A lightning protection for the GPS antenna is mandatory. See project deliverables D2-9 and D8 for details.

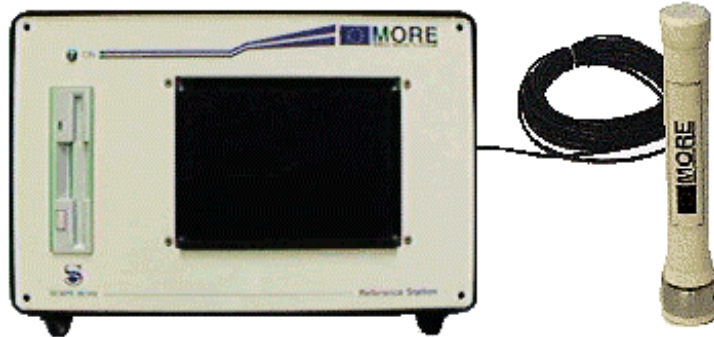

Figure 14: MRS GPS reference station with GPS antenna

The display of the MRS permanently shows the numbers of the currently tracked satellites and the calculated reference position.

Design considerations for D&E and MSC staff:

- The MSC knows corrected user position up to 5m accuracy
- The accuracy and reliability of position data is indicated on the map
- The geographically nearest MRS is chosen by the MSC to provide correction data.

6.3.7 MSC functions

All MSC functions are integrated under the MSC GUI SW. The most important functions provided are (see project WP1 deliverables and D2-3, D5.1):

- Receive SOS call
- Make call (2 simultaneous PSTN lines)
- Call forwarding
- Tracking
- Periodic check
- Show user data
- Show position
- Correct position
- Control MPH
- Logging of alarm events and procedures
- Design considerations for D&E and MSC staff:
- The MSC offers all security services under a powerful single GUI to MPH users
- Checking status of MPH (e.g. battery status)
- Handling of automatic alarms when MPH encounters errors.
- Localising on user request to guide user home
- Additional services like text communication relay services can be integrated

7 Overview on MORE Features

The following tables present an overview on the features in MORE and their connection to the different groups of D&E. The features are grouped by main effect and the planned implementation time is indicated.

Legend:

User classes:

H=Hearing,

S=Speech&voice production,

V=Vision,

L=Locomotion (mobility of lower extremities),

M=Mobility of upper extremities,

E=Elderly (memory),

R=Reading&writing,

C=Consciousness level,

T=Technological motivation,

P=Psycho-cognitive functioning,

Symbols:

• = directly important for a user class

o = for all users, useful for well designed product

7.1 Vision Related Features

User Class	Big graphic display	Big display font 9x8	Symbols instead of text	High contrast display B/W	Anti-glare display window	Tactile feedback from keys	Easy to locate keys, concave	Clearly shaped function keys	Clearly arranged keys	Audio feedback for each operation	Vibrating ringer	MPH finder, reminder	Keys and labelling with high contrast	Speech input	Manual: Braille, Cassette etc.
H					o					o	•				
S					o					o					
V	•	•	•	•	•	•	•	•	•	•	•	•	•	•	•
L					o					o				•	
M					o	•	•		•	o				•	
R					o					o					
C					o					o					
T					o					o				•	
E					o			•	•	o		•			
P			•		o					o				•	

7.2 Emergency/SOS Related Features

User Class	SOS button	External alarm input	Compatible with SAFE21	Configurable SOS sequence, fallback to 112	GPS localisation on request or last available	GPS Correction	Fast GPS start-up and reacquisition	Long standby and operating time	SOS reserved battery management	Personalised SOS speech message	User identification and user data in MSC
H	o	o	o	o	o	o	o	o	o		o
S	o	o	o	o	o	o	o	o	o	•	o
V	o	o	o	o	o	o	o	o	o		o
L	o	o	o	o	o	o	o	o	o		o
M	o	o	o	o	o	o	o	o	o		o
R	o	o	o	o	o	o	o	o	o		o
C	o	o	o	o	o	o		o	o		o
T	o	o	o	o	o	o	o	o	o		o
E	o	o	o	o	o	o	o	o	o		o
P	o	o	o	o	o	o	o	o	o		o

7.3 Easy MMI Related Features

User Class	Phone book	Short dial	Default area code	Auto answer of incoming call	Configurable, easy navigation MMI	Auto dial	Remote configuration	Auto Power On with SOS	Key protection by key press or mechanical	Place for labels on back	Operation like POT	Configurable complexity and speed of MMI	4/2/1 pre-programmed (big) buttons	Big numeric only keyboard (labelling)	Online help
H	o	o			o			o	o			o			o
S	o	o			o			o	o			o			o
V	o	o			o			o	o			o		•	o
L	o	o		•	o			o	o			o			o
M	o	o	•	•	o			o	o			•	•		o
R	o	o			o			o	o			o			o
C	o	o			o			o	o			o			o
T	o	o	•		•		•	o	o	•	•	•		•	o
E	o	o	•		•	•	•	o	•	•	•	•		•	o
P	o	o	•		•		•	o	o		•	•	•	•	o

* Note: The MPH can be easily modified to have only 4 (or 2/1/even 0) dial keys instead of the usual 12 dial keys (0-9 and *, #). While this removes the possibility to dial free numbers it allows the remaining dial keys to be kept clearly separated (e.g. for people with a hand tremor) and also provide enough space to label the dial keys with clear symbols (e.g. for people needing an icon as association with the person to call). The 4-dial-key version is a compromise between the available space and the flexibility to decide whom to call.

7.4 Motion Related Features

User Class	Single key operation	Fits good into hand, non slippery	Decreased Size	Key operation not critical	Provisions to guide fingers (grid)	Low weight	Robust, sturdy, waterproof	Can be operated lying on the table with one hand	Flexible wearing and mounting support	Interface to general aids	Connection to external keyboard
H		o	o				o			o	•
S		o	o				o			o	
V		o	o	•	•		o			o	•
L		o	o				o	•	•	o	
M	•	•	•	•	•	•	o		•	o	•
R		o	o				o			o	
C		o	o				o			o	
T		o	o				o			o	
E		o	o				o		•	o	
P		o	o				o			o	

7.5 Hearing Related Features

User Class	Speech output for basic functions	Extra high speaker volume	Hook-On for hearing aids with T-coil	Text communication	Remote antenna (GPS antenna)	Built in inductive loop	Built in light hands free accessory
H		•	•	•	•	•	•
S				•			
V	•						
L							•
M							•
R							
C							
T							
E							
P	•						

7.6 Safety Related Features

User Class	Reminder alarm	Tracking, also limited area	Dead-man detection	Remote activated external alarm signal	Long standby time	Long operation time	Programmed On and Off	GPS correction
H	o	o	o	o	o	o		o
S	o	o	o	o	o	o		o
V	o	o	o	o	o	o		o
L	o	o	o	o	o	o		o
M	o	o	o	o	o	o		o
R	o	o	o	o	o	o		o
C	o	•	•	o	o	o		o
T	o	o	o	o	o	o		o
E	o	o	o	o	o	o	•	o
P	o	•	o	•	o	o		o

7.7 MSC Related Features

User Class	SOS call management	Tracking management	Periodic check management	Relay services (text communication)	Online help	General services (care&health)	Phone/Fax link to rescue organisation	GPS correction via MRS	Indication of user position on map	Remote configuration of MPH from MSC	Training, maintenance	MSC has user data
H	o			•			o	o	o		o	o
S	o			•			o	o	o		o	o
V	o	•					o	o	o	•	o	o
L	o	•	•			•	o	o	o		o	o
M	o					•	o	o	o	•	o	o
R	o				•		o	o	o		o	o
C	o	•	•			•	o	o	o		o	o
T	o				•		o	o	o	•	o	o
E	o	•	•		•	•	o	o	o	•	o	o
P	o	•	•		•	•	o	o	o	•	o	o

8 Accessories to MPH for Special User Groups

The following table presents the accessories that are planned to supplement the MPH to match best the different user's needs.
 (Black = essential, Grey = good to have, white = not important)

ACCESSORY	GROUP	Visually Impaired	Hearing Impaired	Motion/Locomotion Impaired	Mentally Impaired	Just SOS
CHARGERS	Mains Charger	Black	Black	Black	Black	Black
	Table Charger	Grey	Grey	Black	Grey	Grey
	For cigarette lighter	White	White	Grey	White	White
AUDIO	Hook On	White	Black	White	White	White
	Head Set	Grey	Grey	Black	White	Grey
PC / COMMUNICATOR	Ext. display, keyboard	Grey	Grey	Grey	Grey	White
	Text communication	White	Black	White	White	White
	GSM data (Email/Fax)	White	Grey	White	White	White
HOME STATION	Charger	Grey	Grey	Black	Black	Grey
	Ext. alarm button	White	White	White	White	Black
	Ext. Keyboard	Grey	White	Black	Grey	White
	Single key input	White	White	Black	Black	White
	Hands Free	Grey	Black	Grey	Grey	Black
MECHANICAL	Table stand	Grey	White	Black	White	White
	Helping handles, grid	White	White	Black	White	White

	Wearing, mounting					
	Ext. GSM antenna					
	Ext. wired alarm button					
CAR INSTALLATION	Mounting					
	Ext. GSM/ GPS antenna					
	Handset, Hands Free					
EMERGENCY FEATURES	Ext. Flashlight, siren					
	Wireless SOS button					
	Wireless door lock					
	MPH locator +reminder					
	Motion/shock sensor					
	Vitality sensor					

Table 11: Special user groups and importance of accessories.

9 Conclusions

A mobile communication and emergency call system like MORE for the disabled and older can help these groups to escape from their dependence on personal assistance or the need for staying at home for safety reasons. Ordinary GSM phones have not been designed to be easily usable by people with poor vision, hearing, memory, mobility or older people, who are not used to modern technology. As can be seen from the scenarios described above, the MORE phone together with the services provided by the MORE service centre directly addresses the needs of disabled and older users by providing them a highly configurable interface to the MORE services for independent communication, emergency call and localisation.

The MORE system also holds potential for improving existing alarm and social services and to introduce new services by easing communication between service providers and service users while allowing the clients to stay independent and mobile without compromising their safety. Service costs can be cut by provision of only the actually needed services avoiding institutionalisation on suspect and fast help in an emergency case.

The tests with the developed MORE prototypes verified the implemented functions and, although some features could not successfully be integrated into the prototypes, the MORE concept has been appreciated by all persons to whom the system was demonstrated.

Currently the MORE prototypes are under preparation for a redesign for production. By utilisation of new technology that came up during the project, many more of the planned features can be implemented in the commercial system to be launched in 2001.

Contact address:

MORE
c/o Mr. Hans Herrmann
Allmandring 30a,
D-70569 Stuttgart
Tel: + 49 711/685 5838
Fax: + 49 711/685 5930
E-Mail: herrmann@mikro.uni-stuttgart.de

Product information:

WWW: <http://www.benefon.com/products/rescuephone/more/index.html>

References:

MORE project internal deliverables, conference papers, brochures and videos.
Please contact the project coordinator (contact address see above) for availability.

i)SAFE21 project test reports about MPH

ii)HAMPIIS project internal deliverables D2, D4

iii) Evaluation of the usefulness of MORE from costs' point of view: Vaarama Marja, PhD, Docent, Research Director*, Voutilainen Päivi, Researcher*, Hyppönen Hannele, Researcher**, * STAKES, Social Research Unit, ** STAKES, Promotion of Independent Living

Literature:

ISO 13407:1999(E) standard on "Human-Centred Design Processes for Interactive Systems"
ETSI DEG/HF-00006 v 0.0.4 Usability evaluation for the design of telecommunication systems, services and terminals.

MORE project deliverables D1, D2-3, D2-9, D3-8, D6-5, D9, D10 (partly restricted to project)

User fit. A practical handbook on user-centred design for Assistive technology. Editors: David Poulson, Martin Ashby, Simon Richardson (HUSAT). TIDE USER consortium. European Commission 1996

Telephones for all. Nordic design guidelines . The Nordic Committee on Disability. Editor: Åse Brandt. NNH 3/95. Rosendahls bogtrykkeri, Esbjerg, 1995

Mobile telephones. The disabled persons' guide to choosing a mobile telephone. Danish Centre for technical aids for rehabilitation and education. Dept. for Universal Design. Editor: Åse Brandt. Werks Offset, Aarhus, 1996

SICONA- and DEFIE-project results on User Needs. A paper presented in MORE kick-off meeting 30-31.1.1997

Telecommunications for All. Eds: Patrick Roe. COST219. DGXIII, Office for official publications of the European Communities, 1995

EIDD Design toolkit draft. European institute for Design and Disability. Barcelona Design Centre (Francesc Aragall) 1996

Extending Quality Urban Service for Added value Living using Interactive Telematics systems: Equality. WP3 User requirements. Matti Ojala (Ed), STAKES 4.4.1996

Human Factors: Guidelines for Designers of Telecommunication Services for Non-expert users. CD-Rom. RACE Project R2092 Lusi. HUSAT Research Institute, 1996

Disaster or opportunity? The impact of telecommunications Deregulation on people with disabilities. COST 219. John Gill and Tony Shupley. Scientific research Unit. RNIB – London. February 1997

Access to Telecommunications for People with special Needs: Proposals for improving and adapting telecommunication terminals and services for people with impairments. Revised draft for ETSI Technical Report. 1991

TRACE: The Trace Resourcebook. Assistive Technologies for Communication, Control, and Computer Access, 1998-99 Edition and information from "<http://www.trace.wisc.edu>"

COST219 : COST219 action "TELECOMMUNICATIONS : ACCESS FOR DISABLED PEOPLE AND ELDERLY" and Draft of "Guidelines on Mobile Phones"

TIRESIAS: TIRESIAS screen font, TIRESIAS consortium

ACCESS: Access prohibited?, Information for designers of public access terminals, J. Gill

CEN: CENELEC standard prEN50134-1-2:1993E Alarm Systems

ISO9241: ISO standard on "Ergonomic requirements for office work with visual display terminals", different parts for keys and displays etc.

NGCA: "Nordic Guidelines for Computer Accessibility", Nordic Cooperation on Disability 1998

EU projects: CORE, SAFE21, INCLUDE, MART, PROMISE, CERTAIN, SATURN, SCOPE, HAMPIIS, PLANEC